

KPW63 TSN
PENCERE SİSTEMİ
PUNCH WINDOW SYSTEM

A	ISI HESAPLARI ve PERFORMANS THERMAL CALCULATIONS and PERFORMANCE	A-01 / A-04
B	ALUMİNYUM PROFİLLER ALUMINIUM PROFILES	B-01 / B-05
C	CAM MONTAJ TALİMATI GLAZING ASSEMBLY	C-01 / C-03
D	CONTALAR GASKETS	D-01 / D-02
E	AKSESUARLAR ACCESSORIES	E-01 / E-05
F	TAM ÖLÇEKLİ PROFİLLER FULL SCALE PROFILES.....	F-01 / F-13
G	PRENSİP SİSTEM DETAYLARI PRINCIPAL SECTIONS.....	G-01 / G-22
H	ÜRETİM TALİMATLARI MANUFACTURING INSTRUCTIONS.....	H-01 / H-26

KPW63 TSN
PENCERE SİSTEMİ
PUNCH WINDOW SYSTEM

ISI HESAPLARI ve PERFORMANS
THERMAL CALCULATIONS
and PERFORMANCE

KPW63 TSN
PENCERE SİSTEMİ
PUNC WINDOW SYSTEM

TEST ÜNİTESİ test specimen	hava geçirgenlik air permeability	su sızdırmazlık watertightness	rüzgar dayanım resist.to wind	RAPOR NO report no
		Static ASTM E 331 +12 psf		AB-0926-T 22-014-PR04 10.2022

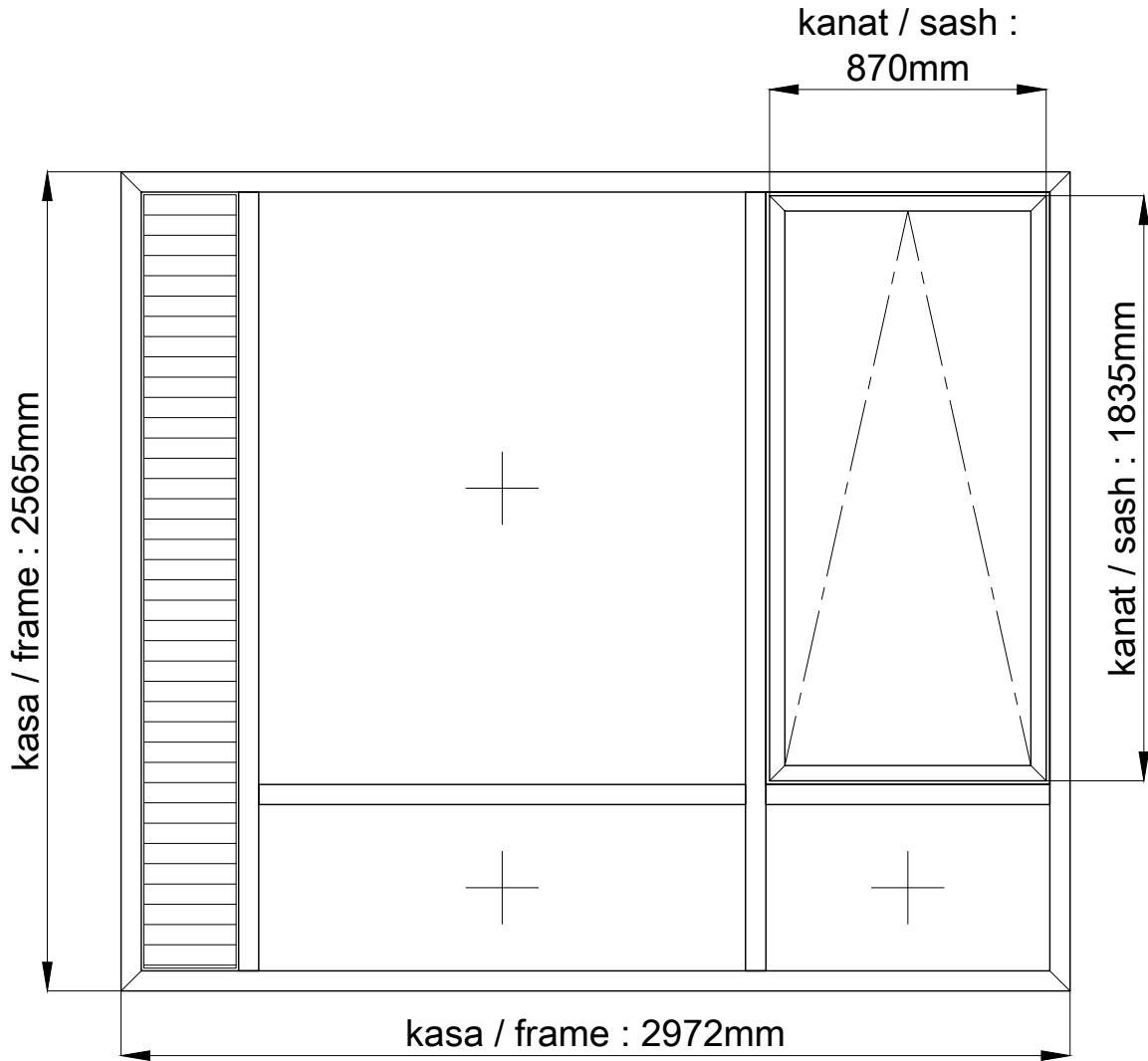

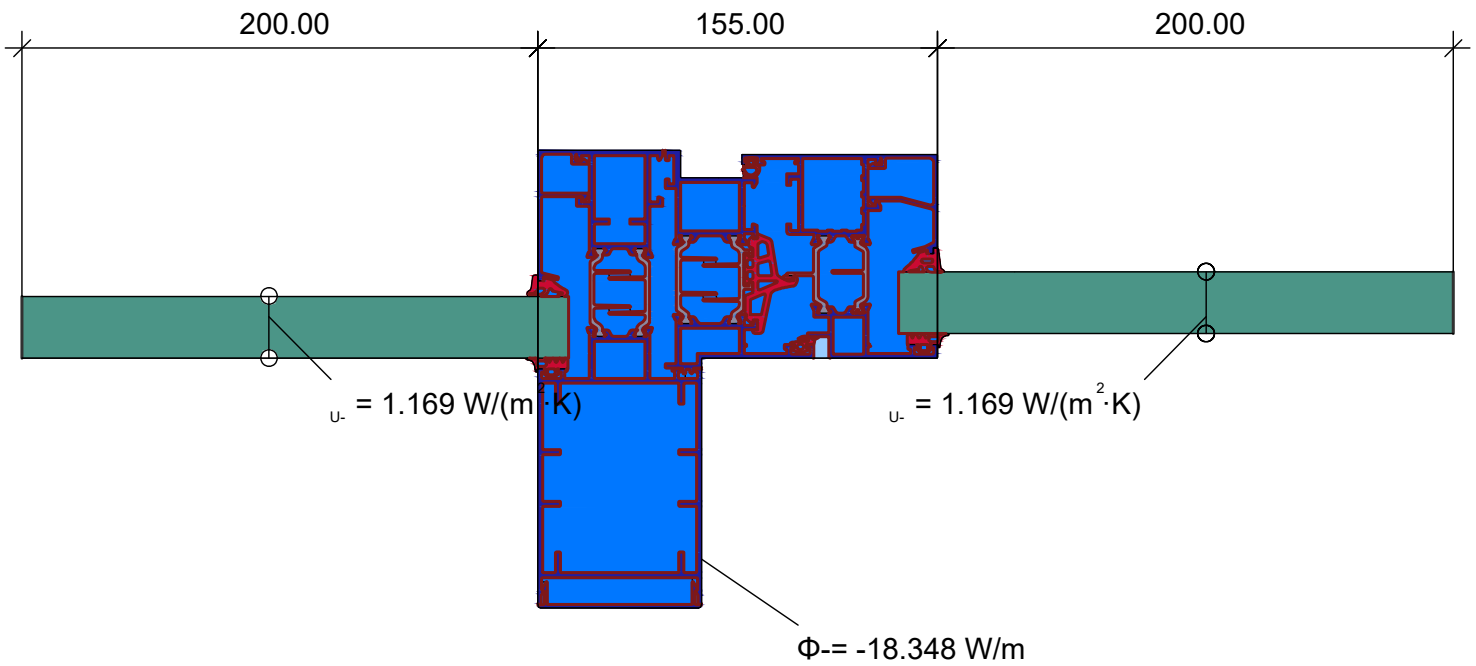

$$U_f = \frac{\Phi}{\Delta T} = \frac{18.348}{20.000 - 1.169 \cdot 0.200 - 1.169 \cdot 0.200} = 2.90 \text{ W}/(\text{m}^2 \cdot \text{K})$$

Material	λ [W/(m·K)]	ϵ	Boundary Condition	q [W/m ²]	θ [C°]	R [(m ² ·K)/W]	ϵ
Aluminium (Si Alloys)	160.000	0.900	Epsilon 0.9				0.900
EPDM (ethylene propylene diene monomer)	0.250	0.900	Exterior, frame	0.000		0.040	
Panel	0.035	0.900	Interior, frame, normal	20.000		0.130	
Polyamid 6.6 with 25% glass fibre	0.300	0.900	Interior, frame, reduced	20.000		0.200	
Slightly ventilated air cavity	anisotropic		Symmetry/Model section	0.000			
Unventilated air cavity	anisotropic						

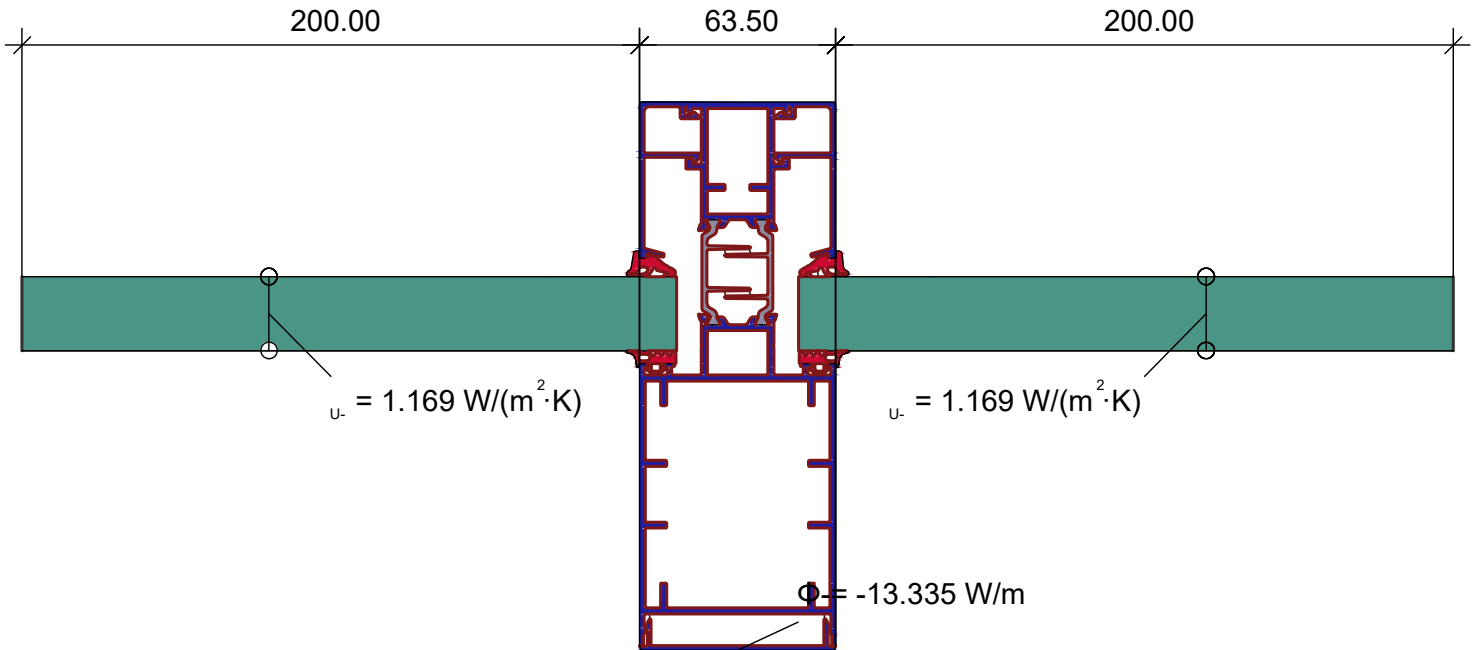

$$U_f = \frac{\Phi}{\Delta T} = \frac{13.335}{20.000 - 1.169 \cdot 0.200 - 1.169 \cdot 0.200} = 3.14 \text{ W}/(\text{m}^2 \cdot \text{K})$$

Material	λ [W/(m·K)]	ϵ	Boundary Condition	q [W/m ²]	θ [C°]	R [(m·K) ² /W]	ϵ
Aluminium (Si Alloys)	160.000	0.900	Epsilon 0.9				0.900
EPDM (ethylene propylene diene monomer)	0.250	0.900	Exterior, frame	0.000		0.040	
Panel	0.035	0.900	Interior, frame, normal	20.000		0.130	
Polyamid 6.6 with 25% glass fibre	0.300	0.900	Interior, frame, reduced	20.000		0.200	
Unventilated air cavity	anisotropic		Symmetry/Model section	0.000			

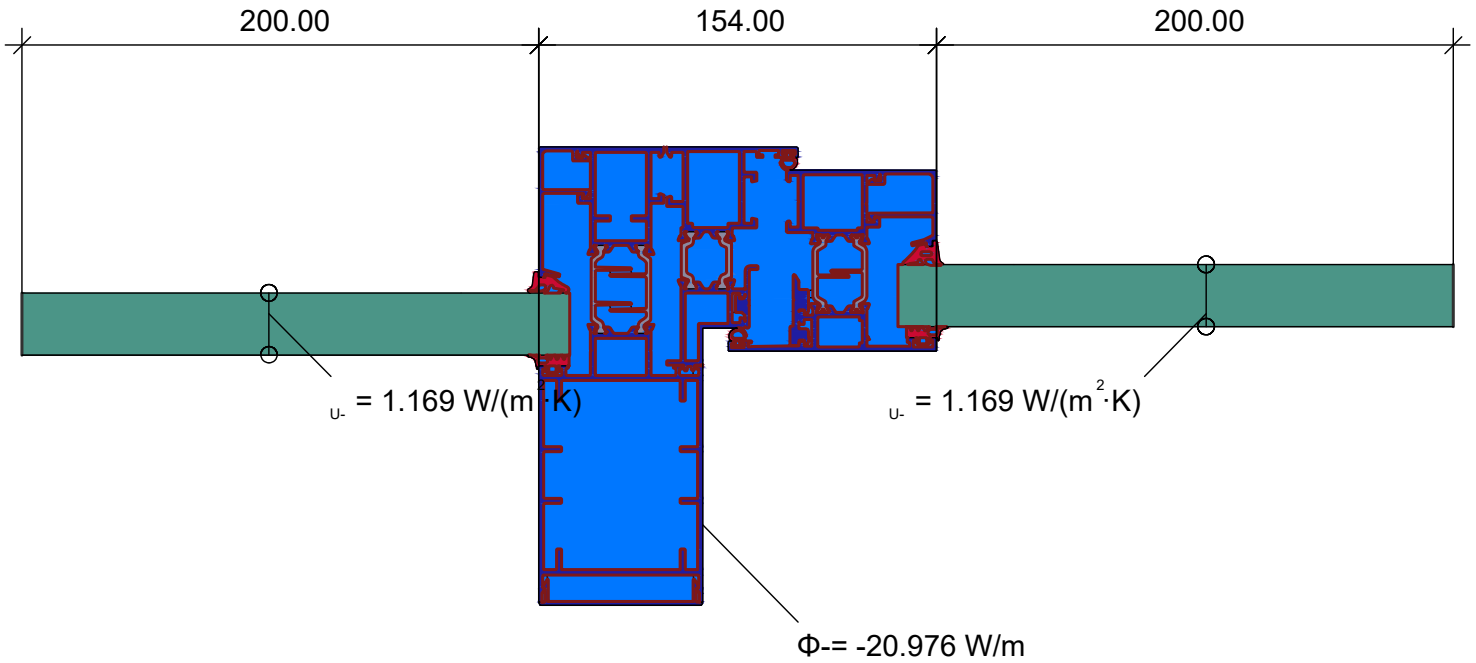









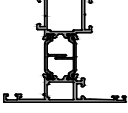
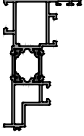
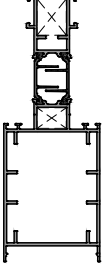
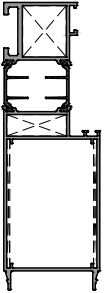



$$U_f = \frac{\Phi}{\Delta T} = \frac{20.976}{20.000 - 1.169 \cdot 0.200 - 1.169 \cdot 0.200} = 3.77 \text{ W/(m}^2 \cdot \text{K)}$$





Material	λ [W/(m·K)]	ϵ	Boundary Condition	q [W/m ²]	θ [C°]	R [(m·K)/W]	ϵ
Aluminium (Si Alloys)	160.000	0.900	Epsilon 0.9				0.900
EPDM (ethylene propylene diene monomer)	0.250	0.900	Exterior, frame	0.000		0.040	
Panel	0.035	0.900	Interior, frame, normal	20.000		0.130	
Polyamid 6.6 with 25% glass fibre	0.300	0.900	Interior, frame, reduced	20.000		0.200	
Unventilated air cavity	anisotropic		Symmetry/Model section	0.000			

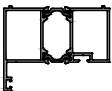



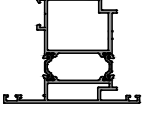
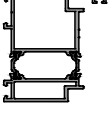
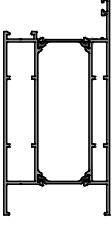
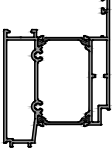



KPW63 TSN
PENCERE SİSTEMİ
PUNCH WINDOW SYSTEM



ALUMİNYUM PROFİLLER
ALUMINIUM PROFILES

PROFİL ŞEKLİ PROFILE SECTION	PROFİL ADI PROFILE NO	KALIP KODU DIE NO	PROFİL TANIMI PROFILE DESCRIPTION	AĞIRLIK WEIGHT
	P 1755	15915 + 15916	VASİSTAS PENCERE KANAT PROFİLİ Awning Window Sash Profile	1,700kg/mt
	P 2270	15917 + 18474	VASİSTAS PENCERE KASA PROFİLİ Awning Window Frame Profile	1,610kg/mt
	P 2272	18465 + 18477	ORTAKAYIT PROFİLİ Mullion Profile	3,380kg/mt
	P 2273	18473 + 18476	KASA PROFİLİ Frame profile	3,700kg/mt
	P 2274	18475	KASA için KAPAK PROFİLİ Cap Profile for Frame	1,095kg/mt

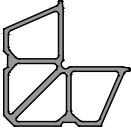
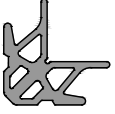
PROFİL ŞEKLİ PROFILE SECTION	PROFİL ADI PROFILE NO	KALIP KODU DIE NO	PROFİL TANIMI PROFILE DESCRIPTION	AĞIRLIK WEIGHT
	P 2275	18479	ORTAKAYIT için KAPAK PROFİLİ Cap Profile for Mullion	0,315kg/mt
	P 1424	11130	ORTAKAYIT MONTAJ PROFİLİ Transom Connecting Bracket	0,945kg/mt
	P 1164	1428	50x50x2 ALU.KÖŞEBENT 50x50x2 ALUMINUM ANGLE	0,540kg/mt
	P 1758	15921	MAKAS ALTLIK PROFİLİ Side Arm Assembly Profile	0,180kg/mt
	P 1759	15922	MAKAS ALTLIK PROFİLİ Side Arm Assembly Profile	0,320kg/mt
	P 2278	18733	DOGRAMA MONTAJ PROFİLİ Strap Anchor Profile	2,105kg/mt
	P 2280	18905	CAM ÇITA PROFİLİ Glazing Bead Profile	0,470kg/mt
	P 2281	10445	METAL PANEL İÇİ U PROFİLİ U Profile for spandrel area	0,230kg/mt
	P 1028	18697 + 18698	ETEK ALT EK PROFİLİ Additional Profile for Sill	1,750kg/mt
	P 1029	18699 + 18700	EŞİK PROFİLİ Threshold Profile	0,710kg/mt

PROFİL ŞEKLİ PROFILE SECTION	PROFİL ADI PROFILE NO	KALIP KODU DIE NO	PROFİL TANIMI PROFILE DESCRIPTION	AĞIRLIK WEIGHT
	P 1207	13917 + 13921	KAPI KANAT PROFİLİ Door Sash Profile	2,120kg/mt
	P 1210	13919 + 13926	KAPI KASA PROFİLİ Door Frame Profile	2,015kg/mt
	P 1215	13933 + 13934	ETEK PROFİLİ Sill Profile	3,150kg/mt
	P 1334	14211 + 14220	ETEK ÜST EK PROFİLİ Additional Profile for Sill	2,310kg/mt
	P 1176	13698	14mm CAM ÇITASI 14mm glazing bead profile	0,335kg/mt
	P 1179	13671	18mm CAM ÇITASI 18mm glazing bead profile	0,350kg/mt
	P 1180	13670	27mm CAM ÇITASI 27mm glazing bead profile	0,380kg/mt
	P 1105	13113	22mm CAM ÇITASI 22mm glazing bead profile	0,360kg/mt

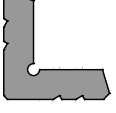
PROFİL ŞEKLİ PROFILE SECTION	PROFİL ADI PROFILE NO	KALIP KODU DIE NO	PROFİL TANIMI PROFILE DESCRIPTION	AĞIRLIK WEIGHT
	P 1158	13111	31mm CAM ÇITASI 31mm glazing bead profile	0,365kg/mt
	P 1494	15306	10mm CAM ÇITASI 10mm glazing bead profile	0,325kg/mt
	P 1495	15307	6mm CAM ÇITASI 6mm glazing bead profile	0,270kg/mt
	P 1496	15308	2mm CAM ÇITASI 2mm glazing bead profile	0,245kg/mt
	P 1497	15309	40mm CAM ÇITASI 40mm glazing bead profile	0,435kg/mt
	P 1498	15310	36mm CAM ÇITASI 36mm glazing bead profile	0,415kg/mt
	P 1020	12769	TİJ PROFİLİ Rod Profile	0,105kg/mt
	P 2197	9086	KÖŞE TAKOZ PROFİLİ Corner Cleat Profile	3,385kg/mt
	P 2015	9856	KÖŞE TAKOZ PROFİLİ Corner Cleat Profile	3,930kg/mt
	P 2279	13591	ALU KUTU PROFİLİ Alu.Box Profile	0,610kg/mt

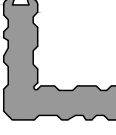
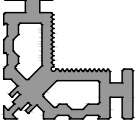
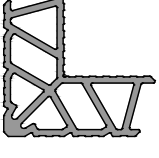
PROFİL ŞEKLİ PROFILE SECTION	PROFİL ADI PROFILE NO	KALIP KODU DIE NO	PROFİL TANIMI PROFILE DESCRIPTION	AĞIRLIK WEIGHT
	P 1015	338	KÖŞE TAKOZ PROFİLİ Corner Cleat Profile	5,990kg/mt
	P 1016	12254	KÖŞE TAKOZ PROFİLİ Corner Cleat Profile	4,910kg/mt
	P 1118	5542	KÖŞE TAKOZ PROFİLİ Corner Cleat Profile	7,245kg/mt
	P 1221	3223	KÖŞE TAKOZ PROFİLİ Corner Cleat Profile	7,065kg/mt
	P 1116	13248	KÖŞE TAKOZ PROFİLİ Corner Cleat Profile	5,710kg/mt

KPW63 TSN
PENCERE SİSTEMİ
PUNCH WINDOW SYSTEM

CAM MONTAJ TALİMATI
GLAZING ASSEMBLY

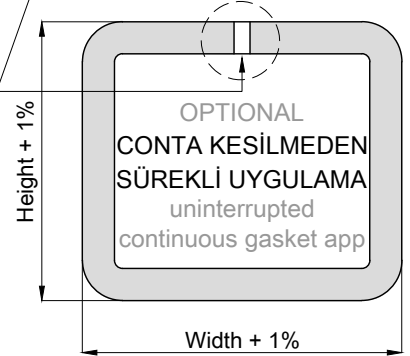
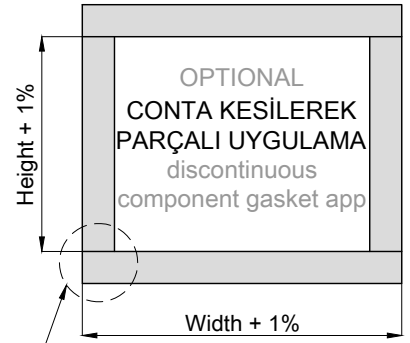
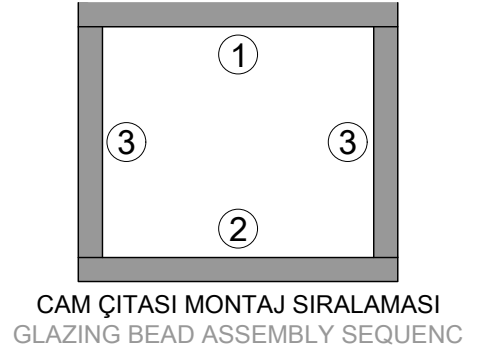
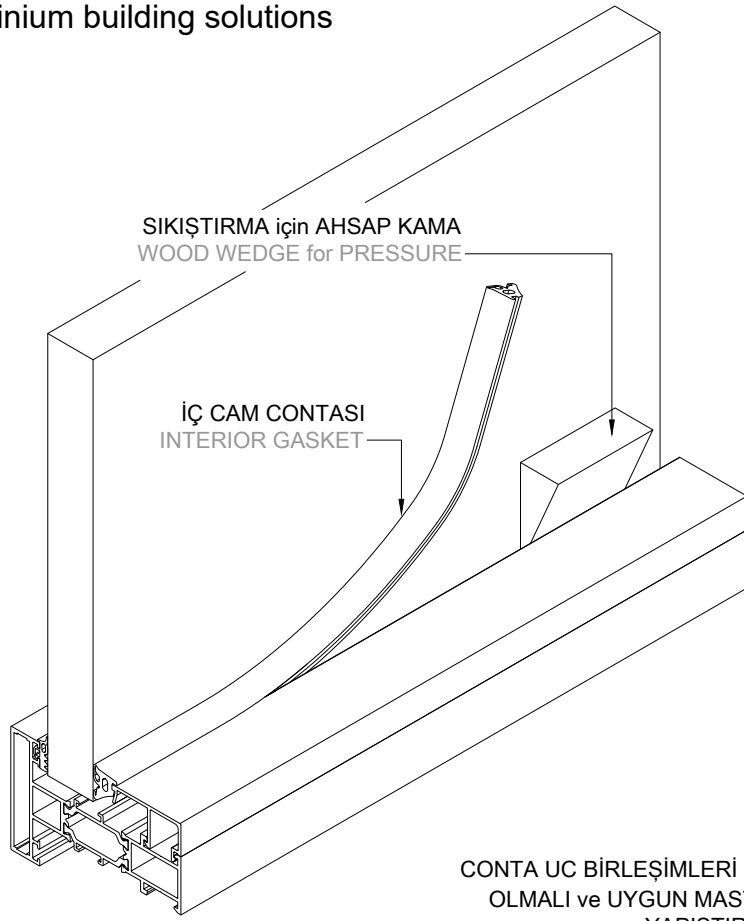

CONTA UC BİRLEŞİMLERİ ÜSTTE
OLMALI ve UYGUN MASTİK İLE
YAPIŞTIRILMALI
GASKET JOINT ON THE TOP,
BOND WITH EPDM GLUE.

① CAM TAKOZU

Cam takozları yerlesimi altta bulunan sematik çizimde gösterilmiştir. takozların kenara mesafeleri kanat ölçüsünün 5/1 i yada 10/1 i kadar olmalıdır.
GLASS CLEATS

The assembly of glass reinforcement pieces has been showed at the top schematically. The gap distance to the corner should be, the 5/1 or 10/1 of the sash size.

② MESAFE AYARLAMA TAKOZU

Mesafe ayar takozları camın alüminyum çerçeve içinde doğru pozisyonda stabil olarak durmasını sağlar. cam ile profil arasına takozları zorlamadan yerleştiriniz.

DISTANCE ADJUSTMENT PIECE

Distance adjustment pieces stabilize the glass in the frame at the true position. Put the distance adjustment piece between glass and profile without using force.

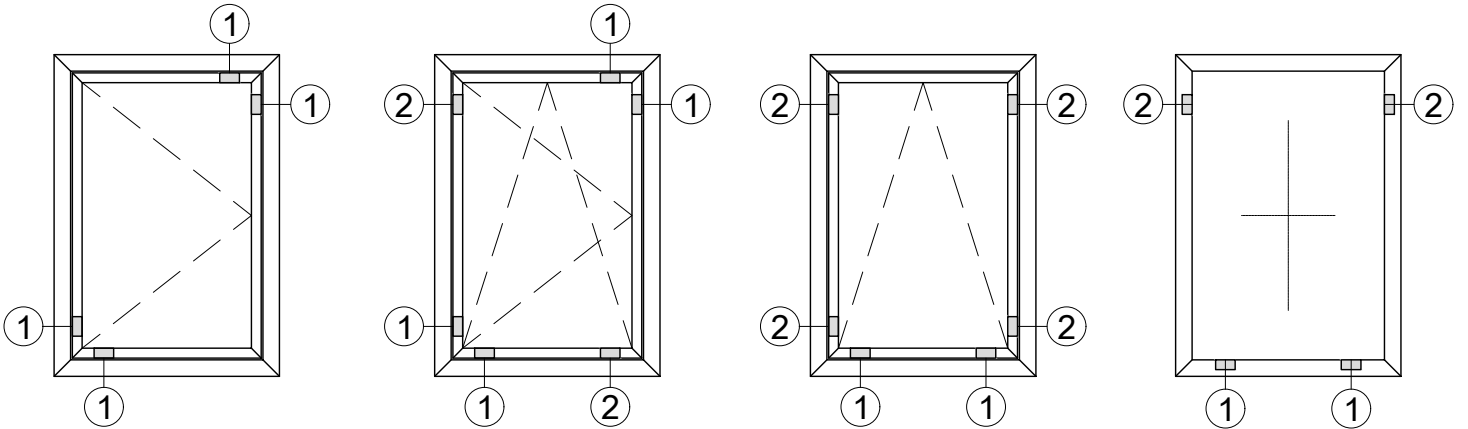







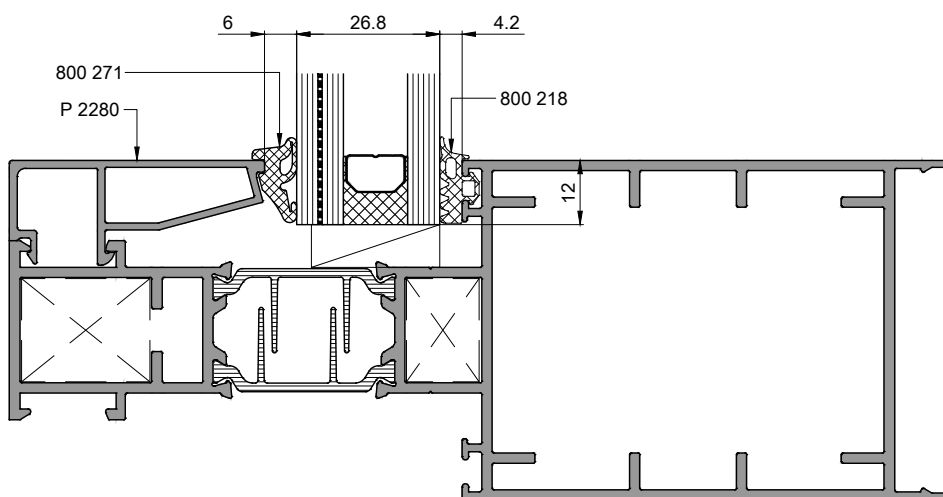
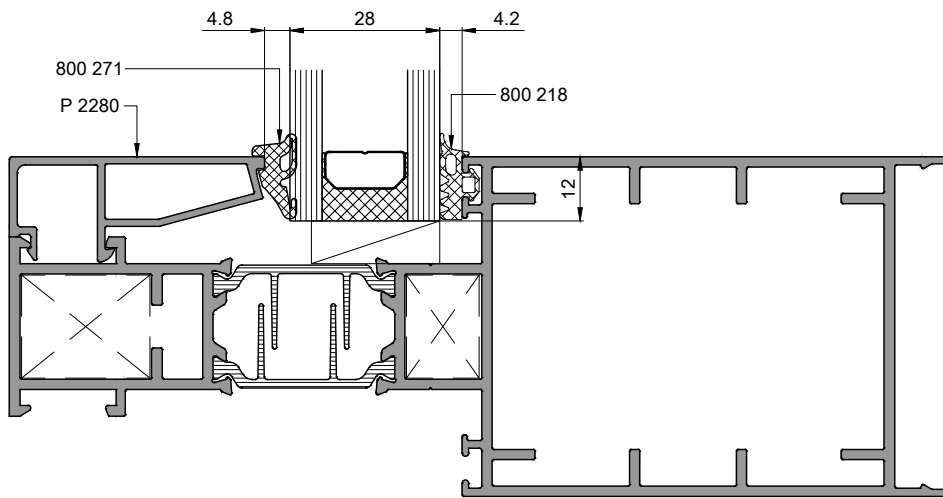

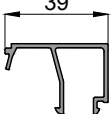

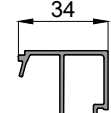





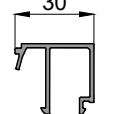

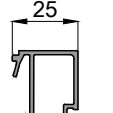

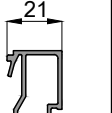

AKSESUAR ve DONANIM MONTAJINDAN ÖNCE,
CAM ve TAKOZLAMA İŞLEMİ YAPILMALIDIR.
THE PANE MUST BE SHIMMED IN THE SASH SO THAT THE SASH
OPERATES WITHOUT ADJUSTMENT OF THE HARDWARE.

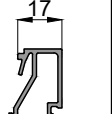
① TAŞIYICI TAKOZ
GLASS CLEAT

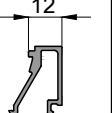
② AYAR TAKOZU
ADJUSTMENT PIECE

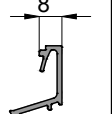

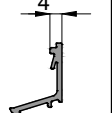
CAM KALINLIĞI glass thickness	ÇİTA glazing bead		CAM CONTASI glazing gasket	
	profil section	kod code	conta şekli section	kod code
14mm	P 1498 (39mm) 	800 277 (8mm)		800 277 (8mm)
16mm				
18mm	P 1158 (34mm) 	800 277 (8mm)		800 278 (10mm)
20mm				800 277 (8mm)
22mm				800 271 (6mm)



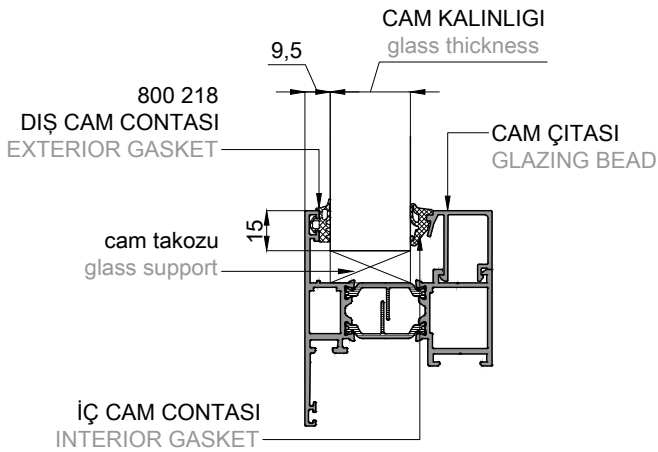







CAM KALINLIĞI glass thickness	ÇİTA glazing bead		CAM CONTASI glazing gasket	
	profil section	kod code	conta şekli section	kod code
24mm	P 1180 (30mm) 	800 277 (8mm)		800 277 (8mm)
26mm				800 278 (10mm)
28mm	P 1105 (25mm) 	800 277 (8mm)		800 277 (8mm)
30mm				800 271 (6mm)
32mm				800 277 (8mm)
34mm	P 1179 (21mm) 	800 271 (6mm)		800 271 (6mm)
36mm				800 277 (8mm)
38mm	P 1176 (17mm) 	800 271 (6mm)		800 271 (6mm)
40mm				800 277 (8mm)
42mm	P 1494 (12mm) 	800 271 (6mm)		800 271 (6mm)
44mm				800 277 (8mm)
46mm	P 1495 (8mm) 	800 271 (6mm)		800 271 (6mm)
48mm				800 277 (8mm)
50mm	P 1496 (4mm) 	800 271 (6mm)		800 271 (6mm)



Yanda tablodaki veriler teoriktir.
Lütfen cam ve conta toleranslarını dikkate alınız.
selection tables promise a first planning.
Please keep the glass and gasket tolerances in mind.

KPW63 TSN
PENCERE SİSTEMİ
PUNCH WINDOW SYSTEM

CONTALAR
GASKETS



CONTA ŞEKLİ GASKET SECTION	CONTA KODU GASKET NO	MALZEME MATERIAL	CONTA TANIMI GASKET DESCRIPTION	PAKET PACKAGE
	800 218	EPDM	DIŞ CAM CONTASI exterior glazing gasket	200mt/pk 0,072kg/mt
	800 271	EPDM	6mm İÇ CAM CONTASI interior glazing gasket	185mt/pk 0,081kg/mt
	800 277	EPDM	8mm İÇ CAM CONTASI 8mm interior glazing gasket	165mt/pk 0,092kg/mt
	800 278	EPDM	10mm İÇ CAM CONTASI 10mm interior glazing gasket	115mt/pk 0,130kg/mt
	800 332	EPDM	İÇ BİNİ CONTASI interior overlap gasket	370mt/pk 0,027kg/mt
	800 386	EPDM	KAPI BİNİ CONTASI overlap gasket for door	481mt/pk 0,027kg/mt
	800 590	EPDM	KANAT SIZDIRMAZLIK CONTASI Tightness Gasket For Awning Sash	272mt/pk 0,055kg/mt
	800 591	EPDM	KASA SIZDIRMAZLIK CONTASI Tightness Gasket For Awning Frame	300mt/pk 0,050kg/mt
	800 398	EPDM	KAPI ALT BİNİ CONTASI Door Bottom Overlap Gasket	115mt/pk 0,131kg/mt
	800 399	EPDM	EŞİK KANAL CONTASI Closing Gasket for Threshold	481mt/pk 0,027kg/mt



CONTA ŐEKLİ GASKET SECTION	CONTA KODU GASKET NO	MALZEME MATERIAL	CONTA TANIMI GASKET DESCRIPTION	PAKET PACKAGE
	800 346	EPDM	DIŐ CAM CONTASI exterior glazing gasket	71mt/paket 0,210kg/mt



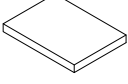
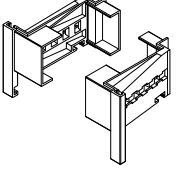
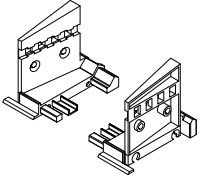
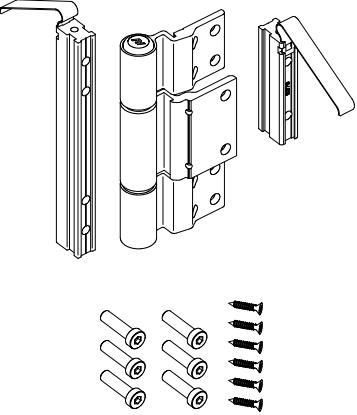

KPW63 TSN
PENCERE SİSTEMİ
PUNCH WINDOW SYSTEM

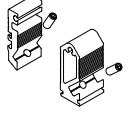
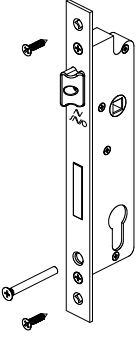
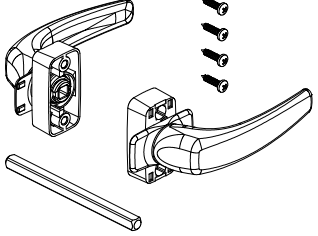
AKSESUARLAR
ACCESSORIES

AKSESUAR ŞEKLİ ACCESSORIES SHAPE	AKSESUAR ACCESS. NO	AKSESUAR TANIMI ACCESSORIES DESCRIPTION	MİKTAR QUANTITY
	700 305	DIŞ CAM CONTASI İÇİN KÖŞE VULKANİZE vulcanized corner for ext.glazing gasket	50 adet/pieces
	700 322	ALUMİNYUM SIKIŞTIRMALI ONBAŞI aluminium corner with allen key	250 adet/pieces
	700 329	KANAT İÇİN ONBAŞI aluminum corner angle for sash	500 adet/pieces
	700 334	KASA İÇİN PVC ONBAŞI pvc corner angle for sash and frame	500 adet/pieces
	700 336	SU TAHLİYE KAPAGI weep hole cap	500 adet/pieces
	700 770	PVC KÖŞE ONBAŞI pvc corner angle for sash	50 adet/pieces
	700 960	KASA ve ORTA KAYIT BİRLEŞİM SÜNGERİ T connection foam for frame and mullion	50 adet/pieces
	700 961	KASA KÖŞE BİRLEŞİM için 3mm ALU.ONBAŞI 3mm Alu Flange for Frame Corner	50 adet/pieces
	700 962	KASA ve ORTA KAYIT BİRLEŞİM ANKRAJİ T connection bracket for frame and mullion	50 çift/pair
	700 963	KASA ve ORTA KAYIT BİRLEŞİM ANKRAJİ T connection bracket for frame and mullion	50 çift/pair

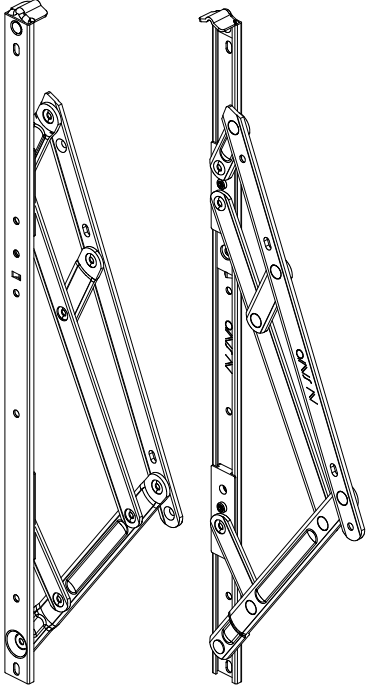
AKSESUAR ŞEKLİ ACCESSORIES SHAPE	AKSESUAR ACCESS. NO	AKSESUAR TANIMI ACCESSORIES DESCRIPTION	MİKTAR QUANTITY
	700 964	KASA ve ORTA KAYIT BİRLEŞİM SÜNGERİ T connection foam for frame and mullion	50 adet/pieces
	700 696	ETEK için PVC ENJEKSİYON pvc cap plug for door sill	20 çift/pair
	700 697	EŞİK için PVC ENJEKSİYON pvc cap plug for door threshold	20 çift/pair
	1143.36	DIŞA AÇILIR KAPI SİLİNDİR MENTEŞE standart renkler : gümüş,beyaz,siyah (2Adet = 100kg) (3Adet = 120kg) CYLINDER HINGES for OUTWARD OPENING DOOR standart colours : silver,white,black (2pieces = 100kg) (3pieces = 120kg)	
	874.804	BAREL KAPAK SETİ standart renkler : gümüş,beyaz,siyah PVC CAP PLUG for CYLINDER standart colours : silver,white,black	

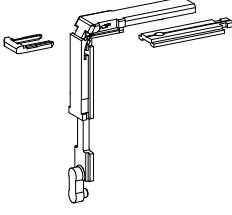
AKSESUAR ŞEKLİ ACCESSORIES SHAPE	AKSESUAR ACCESS. NO	AKSESUAR TANIMI ACCESSORIES DESCRIPTION	MİKTAR QUANTITY
	700 333	KAPI ve ETEK BİRLEŞİM ANKRAJI T connection bracket for door and sill	50 çift/pair
	1852.19 / 30G	DİLLİ KİLİT GÖBEGİ locking device body	
	866.31	ARIANNA - BASMA KOL arianna - manuel handle	
	CT 1	KİLİT KARŞILIGI kilit göbeği için kullanılır KEEPER use with locking device body	
	CT 2	KİLİT KARŞILIGI alt ve üsteki diller için kullanılır KEEPER use for top and bottom additional locking point	

AKSESUAR ŞEKLİ ACCESSORIES SHAPE	AKSESUAR ACCESS. NO	AKSESUAR TANIMI ACCESSORIES DESCRIPTION	MİKTAR QUANTITY
	1330ST - 14	14" MAKAS / SIDE ARM 0.65cm - 0.85cm X 120cm (max. : 48kg)	1 çift/pair
	1330ST - 16	16" MAKAS / SIDE ARM 0.80cm - 100cm X 120cm (max. : 53kg)	1 çift/pair
	1330HD - 20	20" MAKAS / SIDE ARM 140cm - 160cm X 160cm (max. : 115kg)	1 çift/pair
	1330HD - 24	24" MAKAS / SIDE ARM 160cm - 180cm X 180cm (max. : 125kg)	1 çift/pair
	1330HD - 24	28" MAKAS / SIDE ARM 180cm - 200cm X 200cm (max. : 135kg)	1 çift/pair
	1246.832	PENCERE ÜST BASKI additional locking device for top	40 adet/pieces
	1243.710	PİM locking device	40 adet/pieces
	1243.790	KÖŞE AKTARMA corner transmission	10 adet/pieces
	1243.721	AYARLI KARŞILIK adjustable keeper	40 adet/pieces

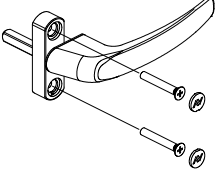
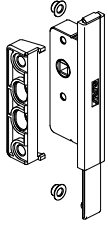
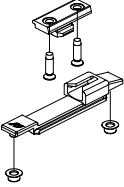
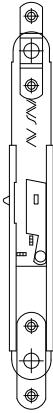
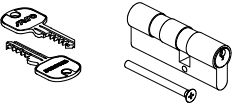
AKSESUAR ŞEKLİ ACCESSORIES SHAPE	AKSESUAR ACCESS. NO	AKSESUAR TANIMI ACCESSORIES DESCRIPTION	MİKTAR QUANTITY
	1609	KOL handle	5 adet/pieces
	1203 - 7	GEAR BOX MEKANİZMA tek yöne hareketli GEAR BOX (1 direction)	10 adet/pieces
	1204 - 7	GEAR BOX MEKANİZMA çift yöne hareketli GEAR BOX (2 direction)	10 adet/pieces
	1246.835	GÜVENLİK KİLİT SETİ anti burglar accessories	40 adet/pieces
	1307.8	KANAT LİMİTLEYİCİ arm stay for sash	1 çift/pair
	1852.801 / 85	BAREL SETİ cylinder locking set	

KPW63 TSN
PENCERE SİSTEMİ
PUNCH WINDOW SYSTEM

TAM ÖLÇEKLİ PROFİLLER
FULL SCALE PROFILES

P 1755

VASİSTAS PENCERE KANAT PROFİLİ / Awning Window Sash Profile
1,700kg/mt

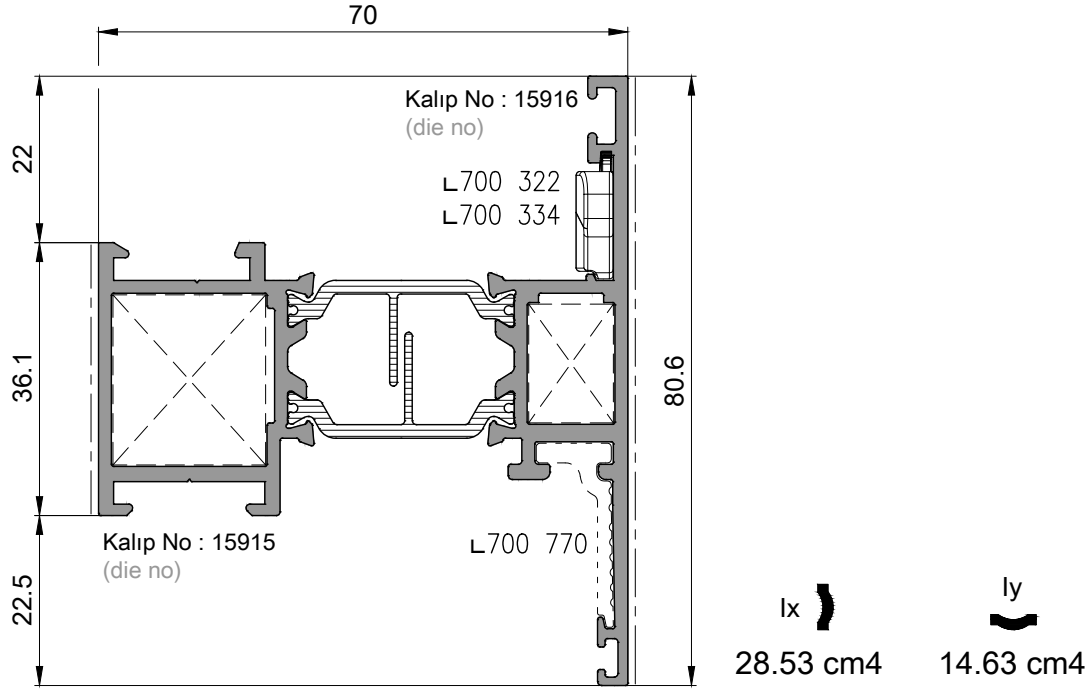

P 2270

VASİSTAS PENCERE KASA PROFİLİ / Awning Window Frame Profile
1,610kg/mt

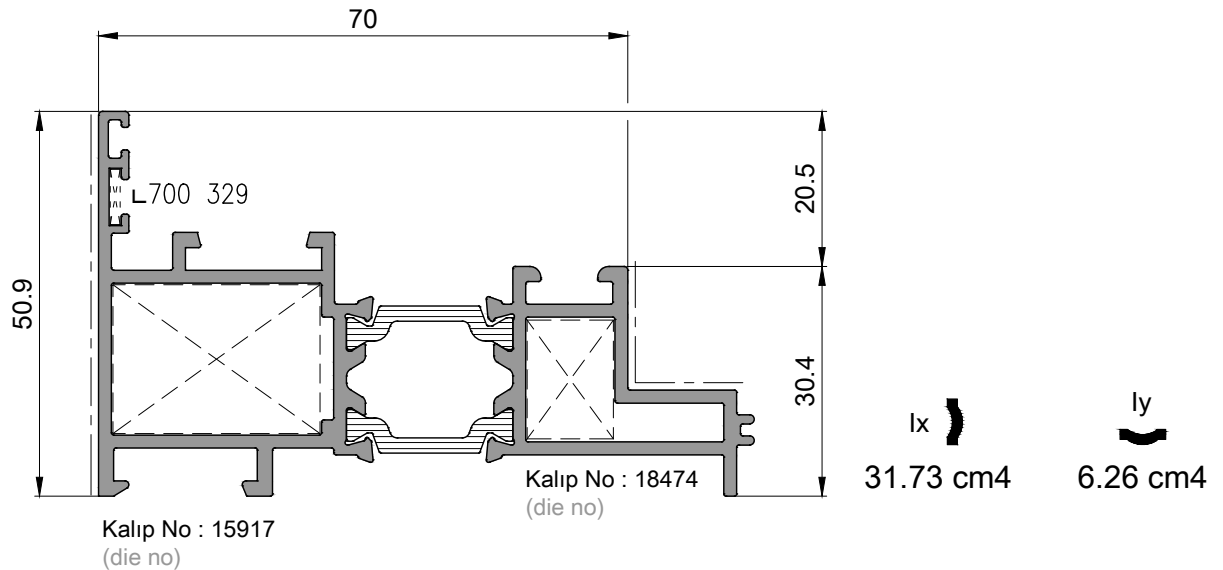

P 2272
ORTAKAYIT PROFİLİ / Mullion Profile
3,380kg/mt

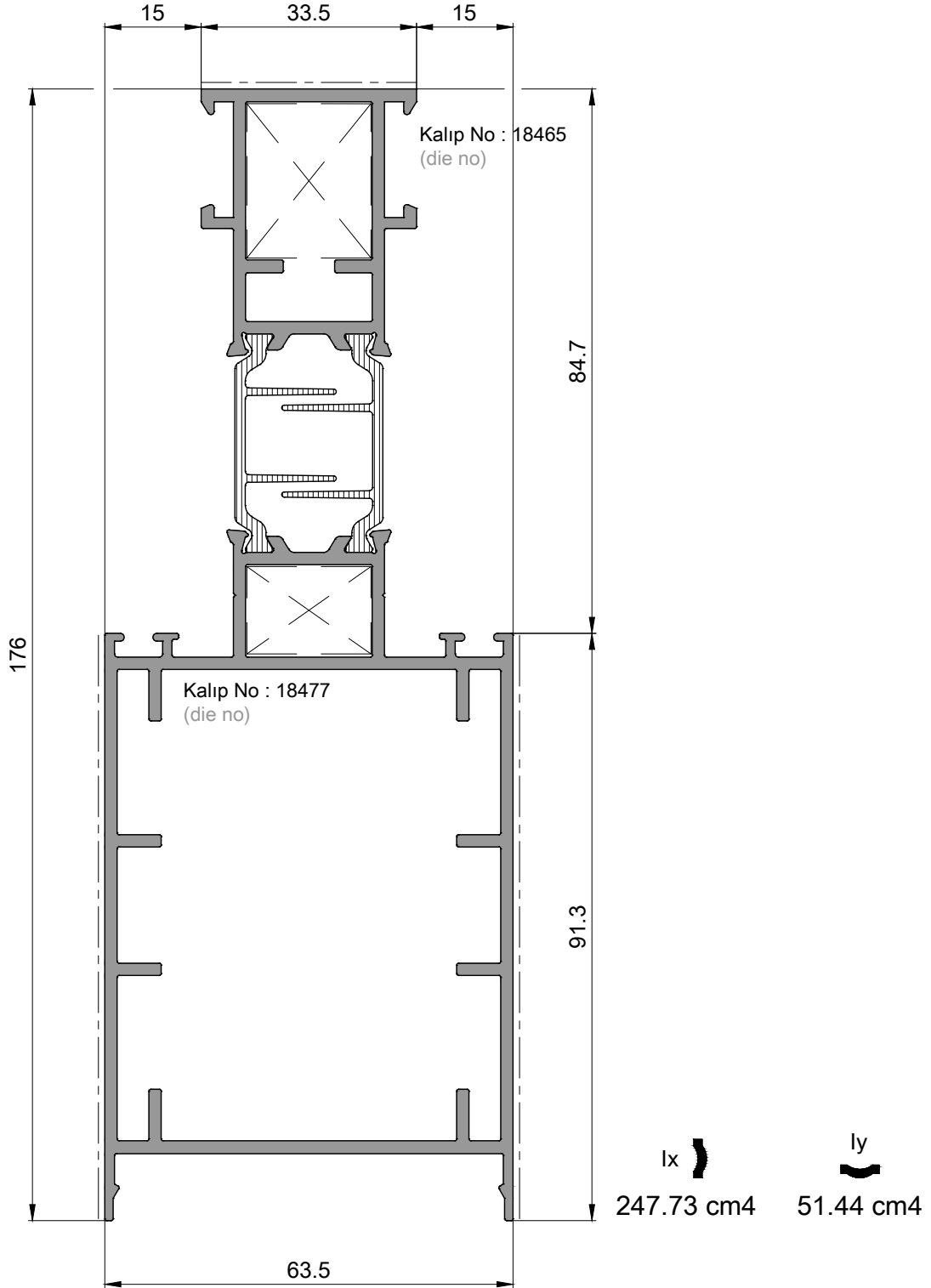

P 2273
KASA PROFILI / Frame Profile
3,700kg/mt

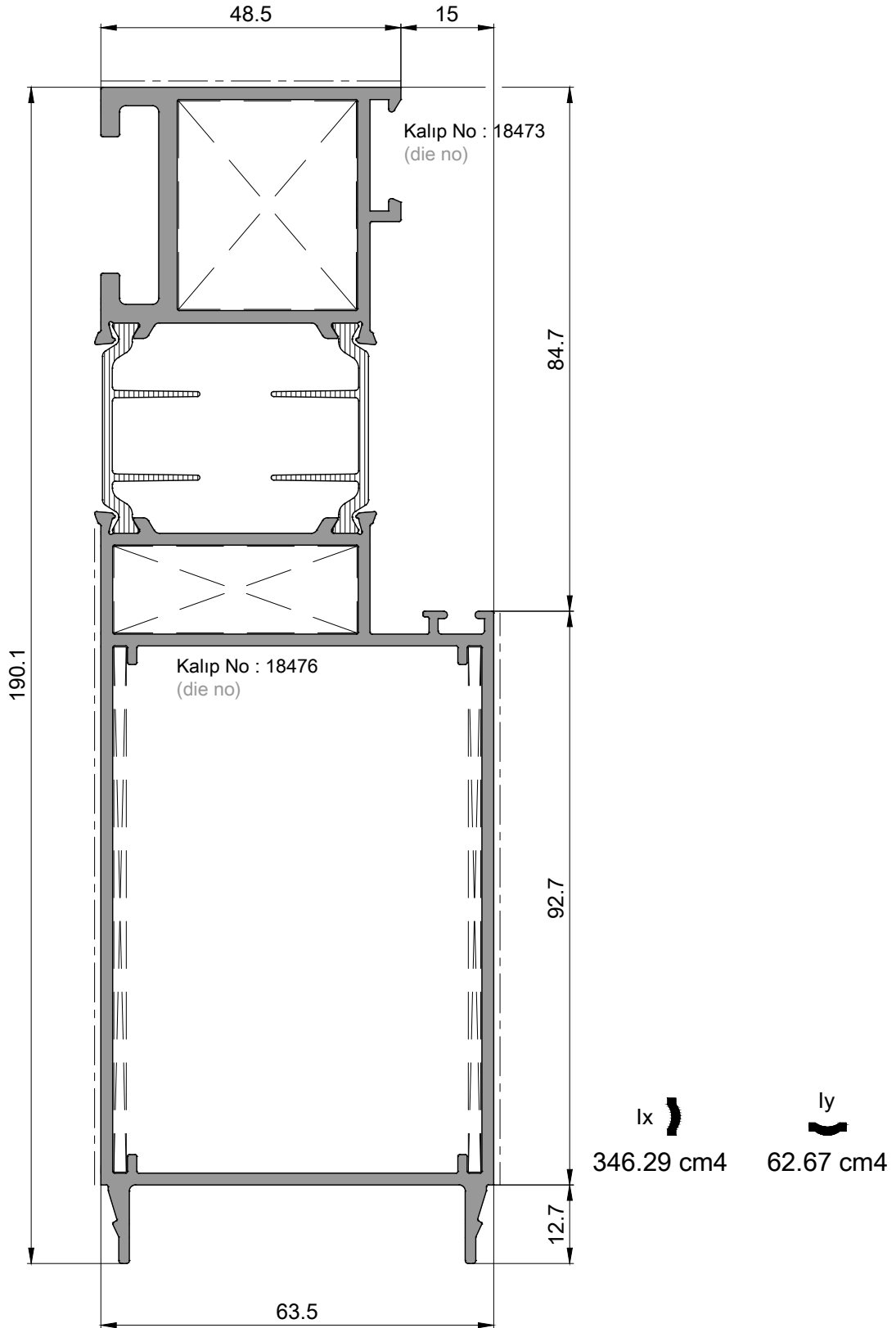

P 2274

KASA için KAPAK PROFİLİ / Cap Profile for Frame
1,095kg/mt

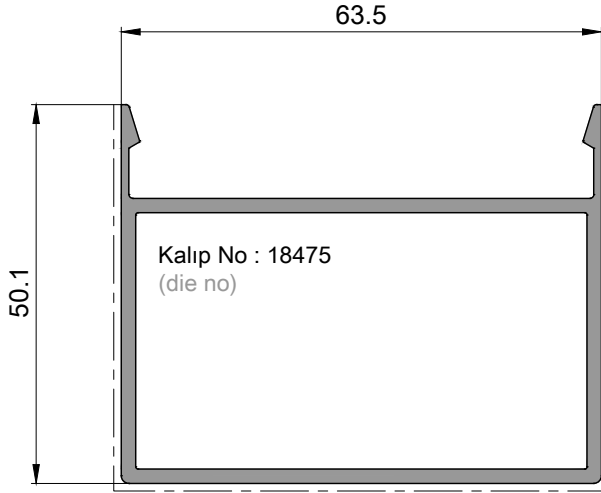

P 1028

ETEK ALT EK PROFİLİ / Additional Profile for Sill
1,750kg/mt

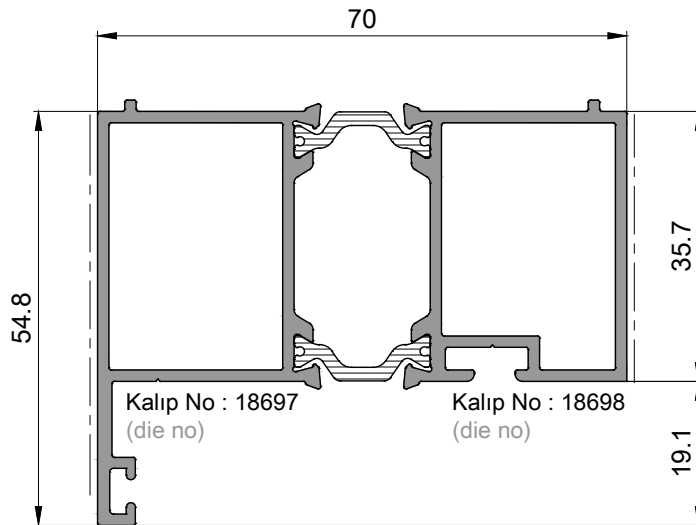

P 1207

KAPI KANAT PROFİLİ / Door Sash Profile
2,120kg/mt

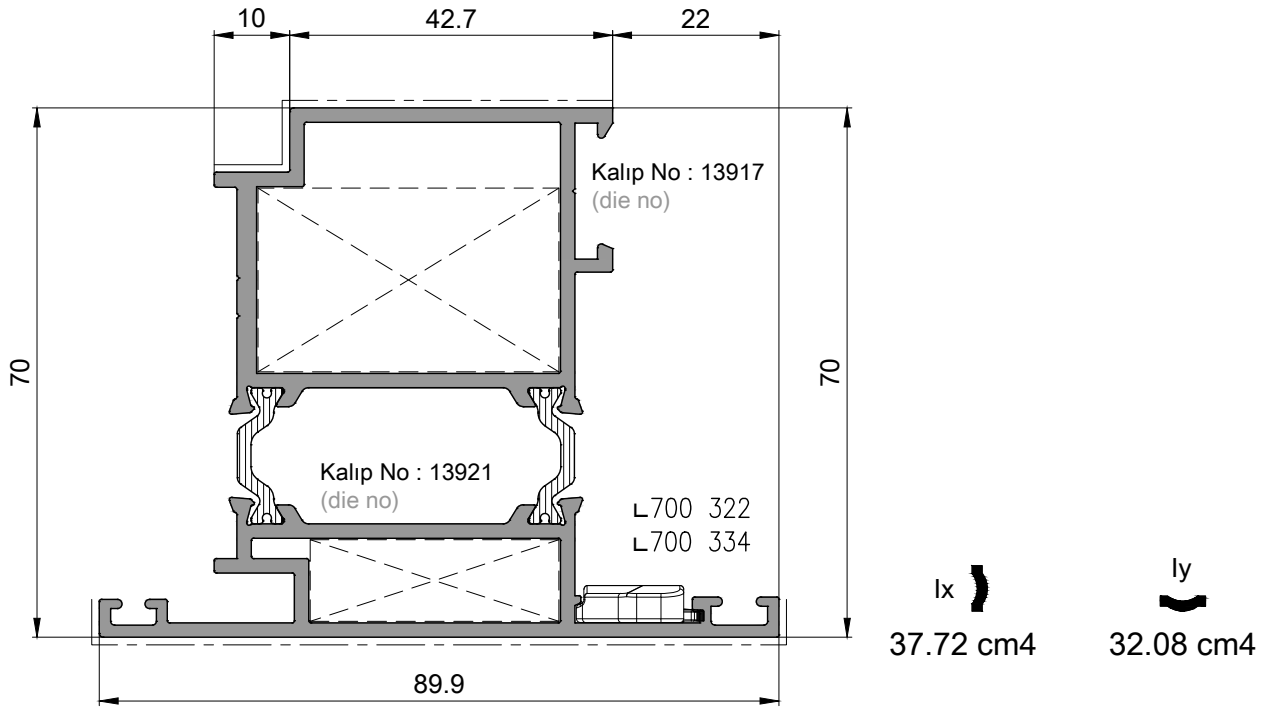

P 1210

KAPI KASA PROFİLİ / Door Frame Profile
2,015kg/mt

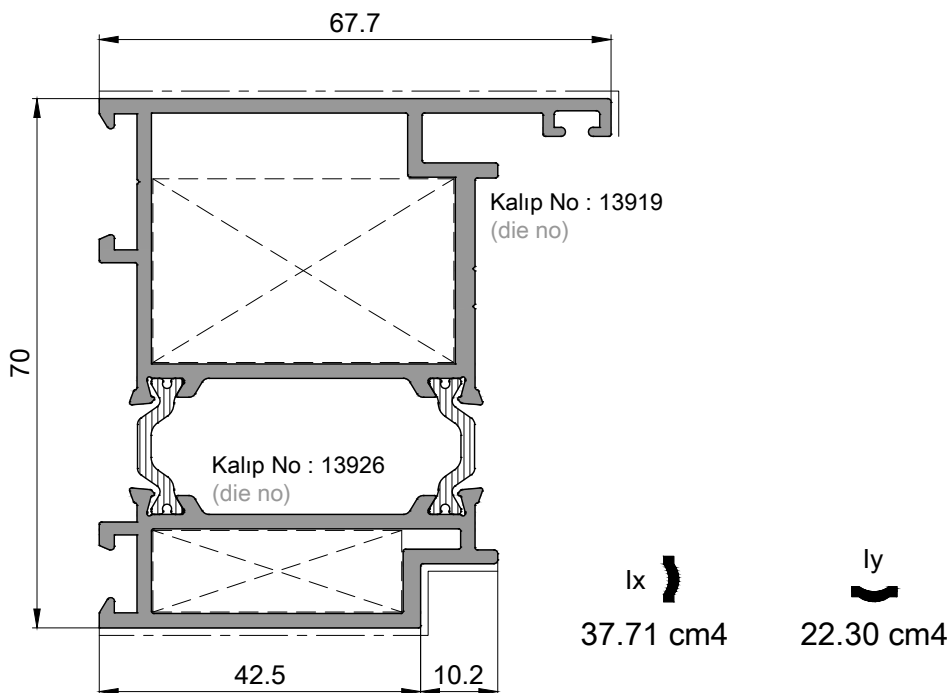

P 1334

ETEK ÜST EK PROFİLİ / Additional Profile for Sill
2,310kg/mt

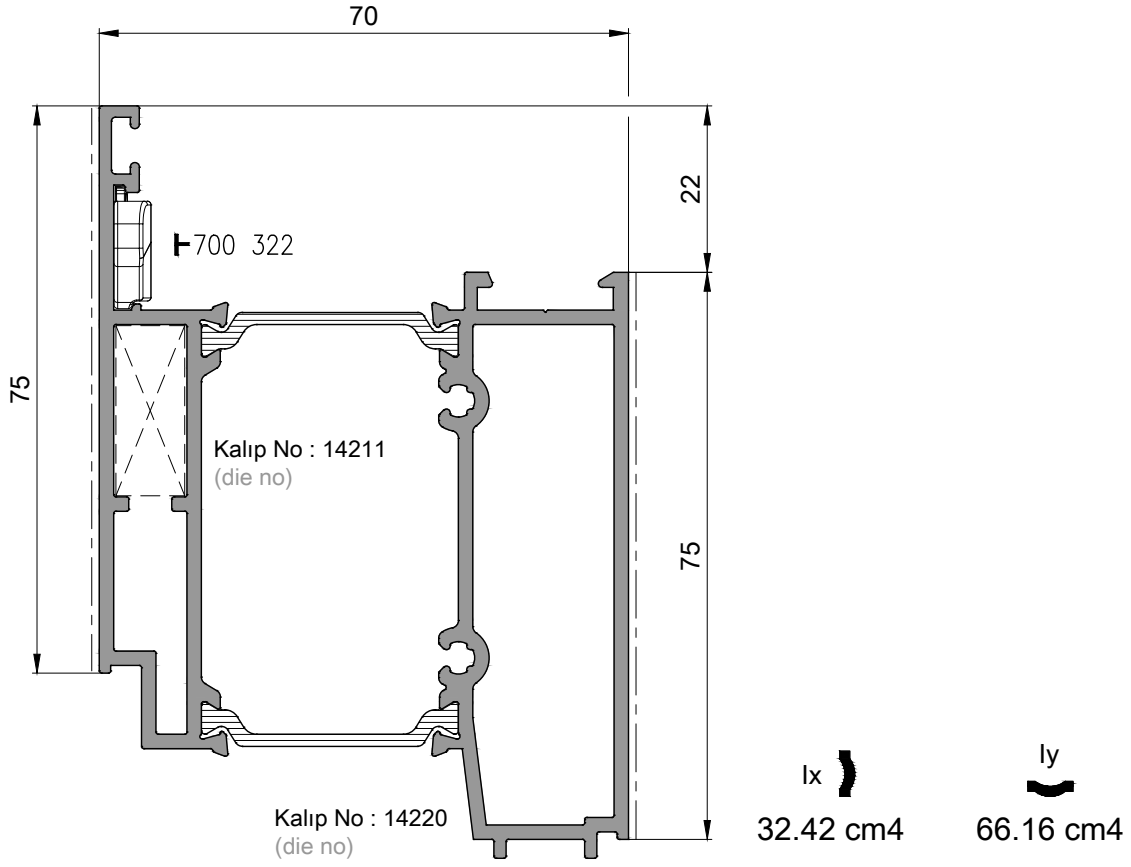

P 1424

Tranzom Montaj Profili / 0,945kg/mt
T Joining Bracket

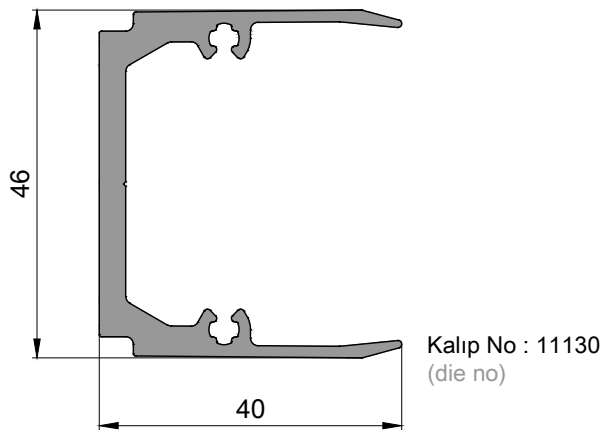

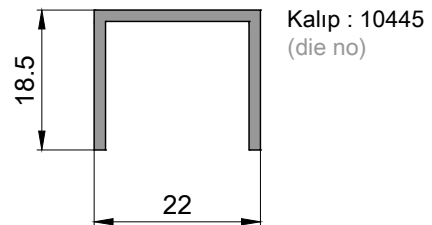

P 2281

Metal panel için U Profil / 0,230kg/mt
U Profile for spandrel area

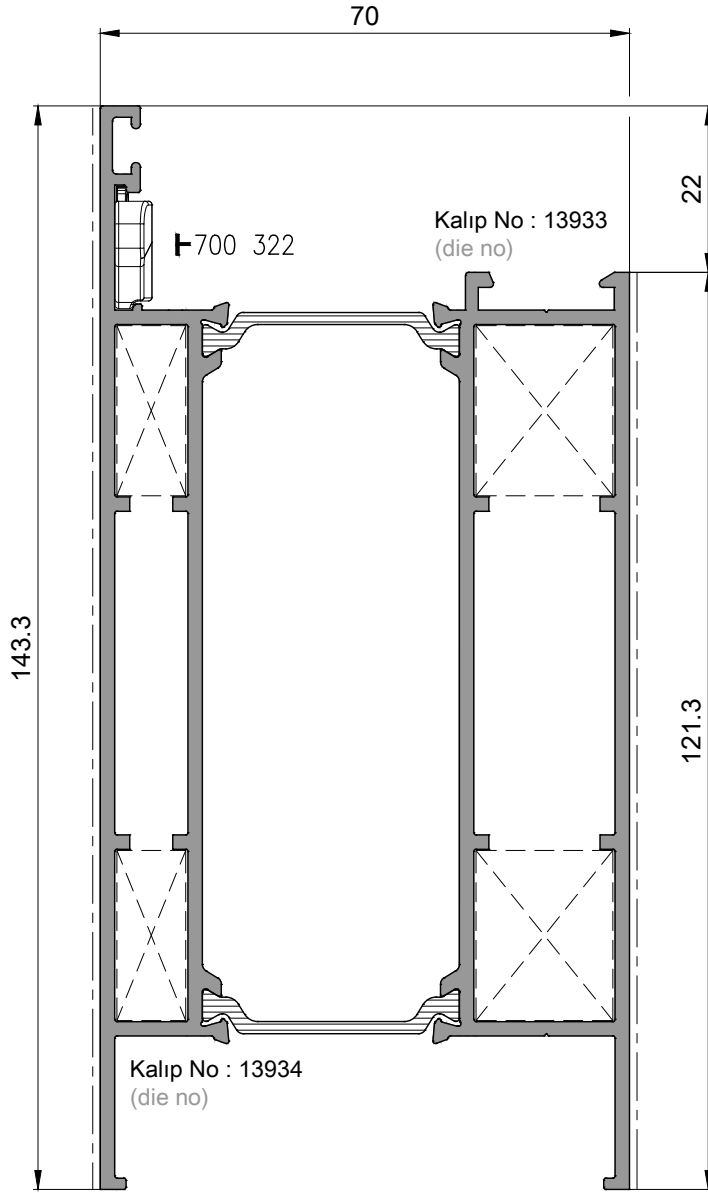

P 1215
E TEK PROFİLİ / Sill Profile
3,150kg/mt



I_x 
69.39 cm⁴

I_y 
154.27 cm⁴

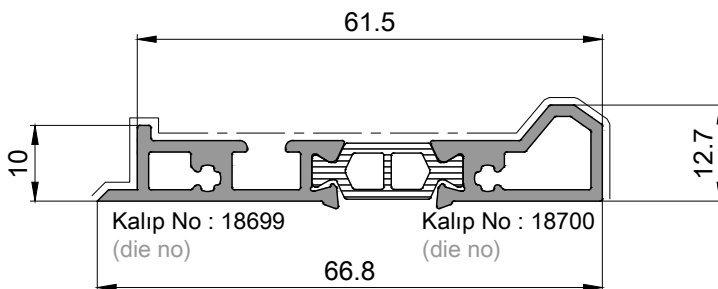

P 1029
EŞİK PROFİLİ / Threshold Profile
0,710kg/mt

P 1176

Çita Profili / 0,335kg/mt
Glazing Bead Profile

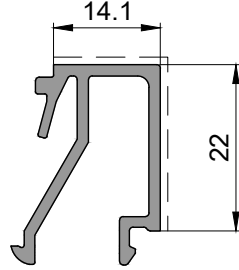

Kalıp No : 13698
(die no)

P 1179

Çita Profili / 0,350kg/mt
Glazing Bead Profile

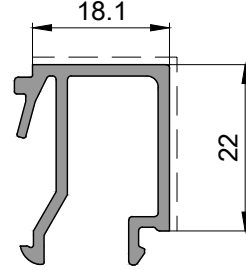

Kalıp No : 13671
(die no)

P 1180

Çita Profili / 0,380kg/mt
Glazing Bead Profile

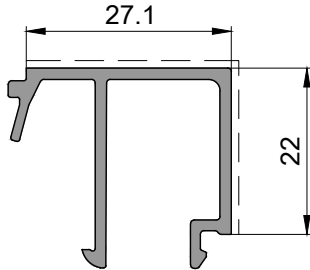

Kalıp No : 13670
(die no)

P 1105

Çita Profili / 0,360kg/mt
Glazing Bead Profile

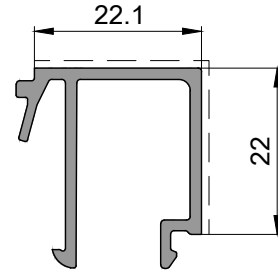

Kalıp No : 13113
(die no)

P 1158

Çita Profili / 0,365kg/mt
Glazing Bead Profile

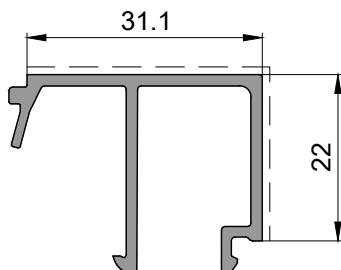

Kalıp No : 13111
(die no)

P 1020

Tij Profili / 0,290kg/mt
Rod Profile

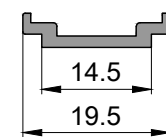

Kalıp : 12769
(die no)

eloxal - anodising

P 1494

Çıta Profili / 0,325kg/mt
Glazing Bead Profile

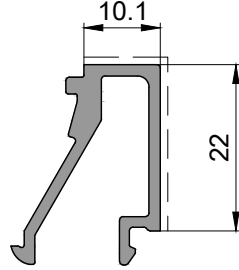

Kalıp : 15306
(die no)

P 1495

Çıta Profili / 0,270kg/mt
Glazing Bead Profile

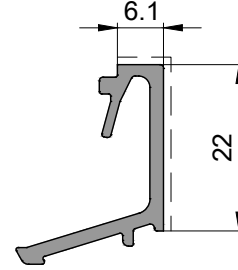

Kalıp : 15307
(die no)

P 1496

Çıta Profili / 0,245kg/mt
Glazing Bead Profile

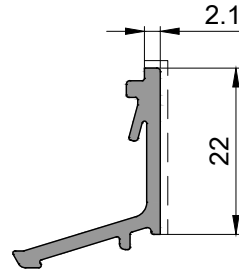

Kalıp : 15308
(die no)

P 1497

Çıta Profili / 0,435kg/mt
Glazing Bead Profile

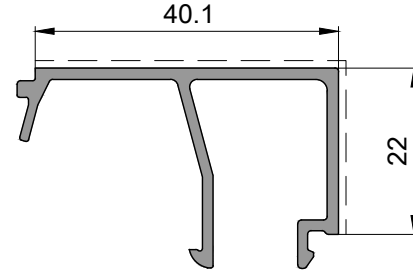

Kalıp : 15309
(die no)

P 1498

Çıta Profili / 0,415kg/mt
Glazing Bead Profile

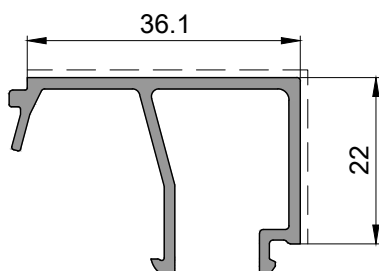

Kalıp : 15310
(die no)

P 2279

Kutu Profil / 0,610kg/mt
Box Profile

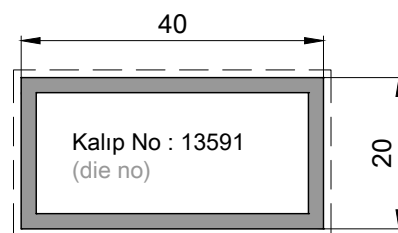

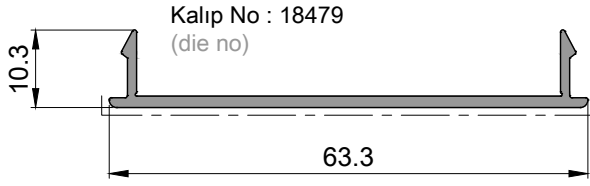

P 2275

ORTAKAYIT için KAPAK PROFİLİ
Cap Profile for Mullion
0,315kg/mt

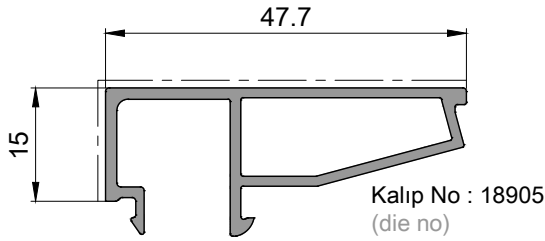

P 2280

CAM ÇITA PROFİLİ / Glazing Bead Profile
0,470kg/mt

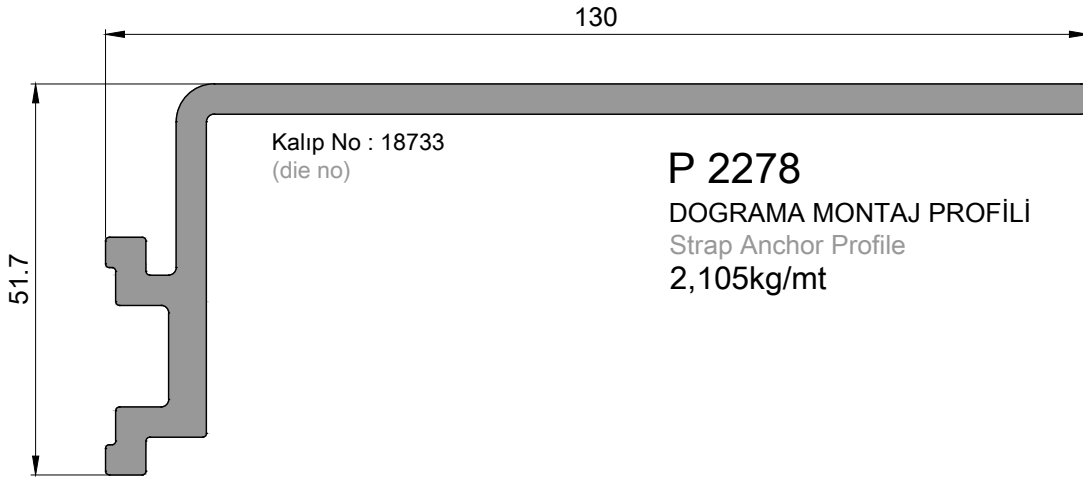

P 2278

DOGRAMA MONTAJ PROFİLİ
Strap Anchor Profile
2,105kg/mt

P 1758

Makas Altılık / 0,180kg/mt
Side Arm Assembly Profile

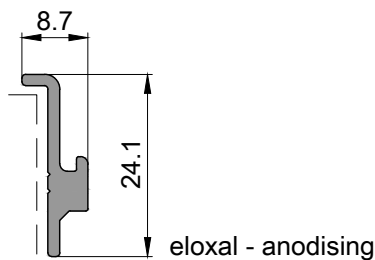

Kalıp : 15921
(die no)

eloxal - anodising

P 1759

Makas Altılık / 0,320kg/mt
Side Arm Assembly Profile

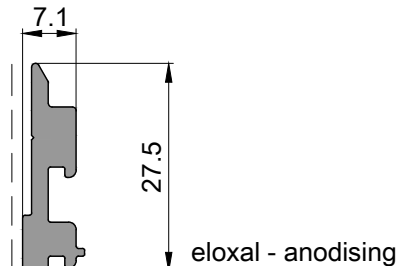

Kalıp : 15922
(die no)

eloxal - anodising

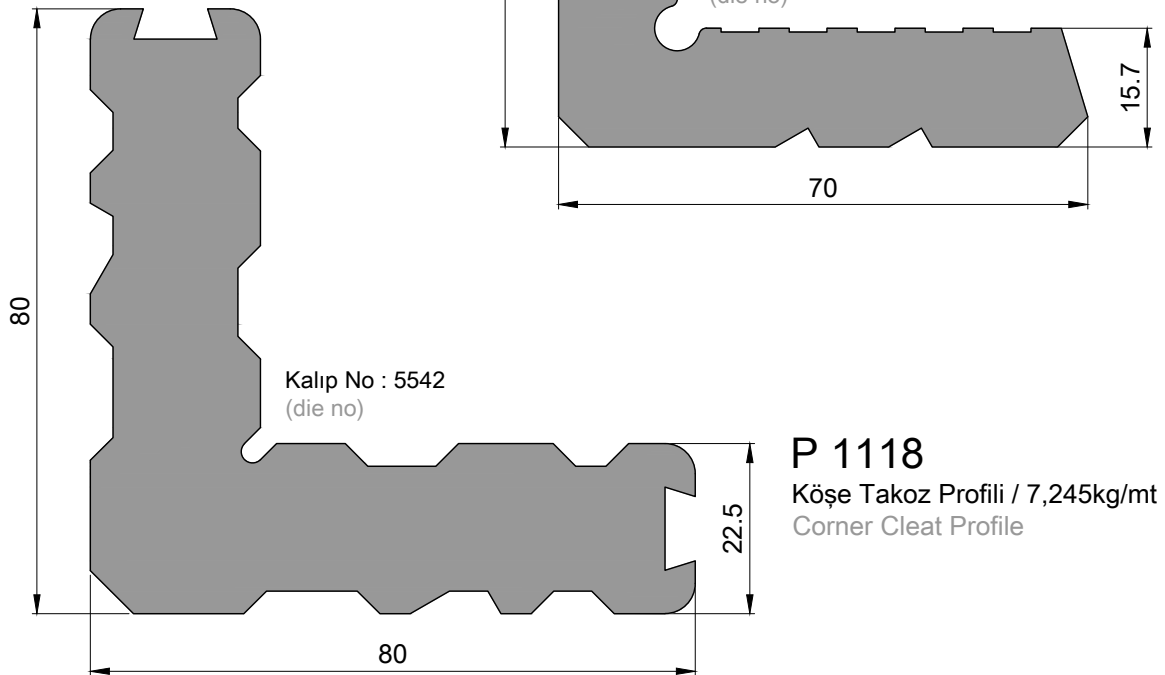
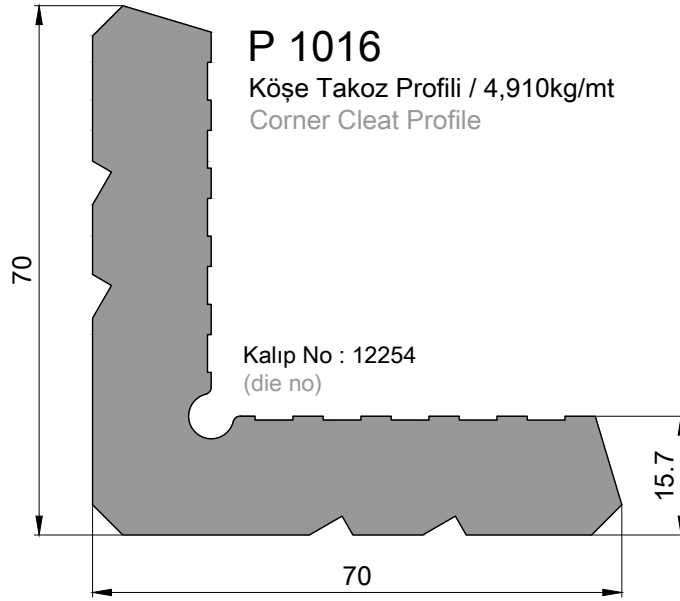
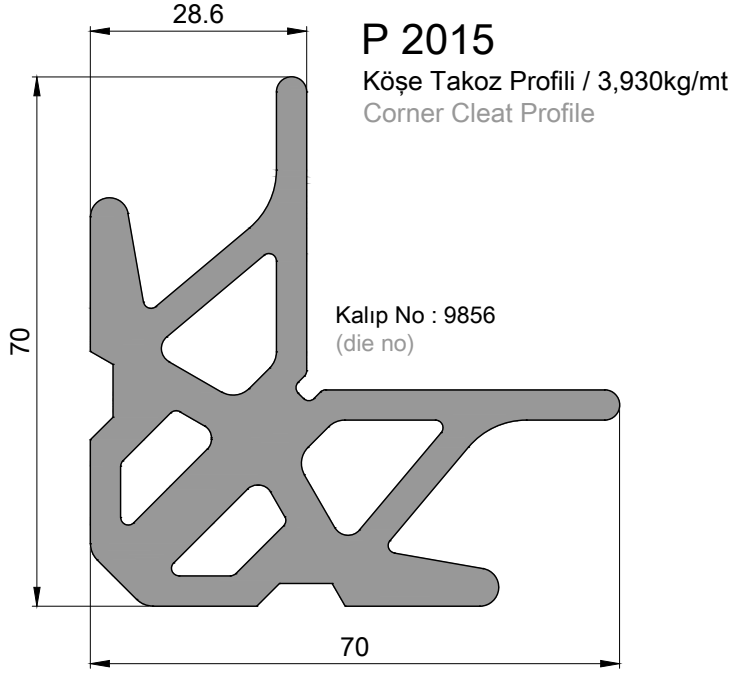

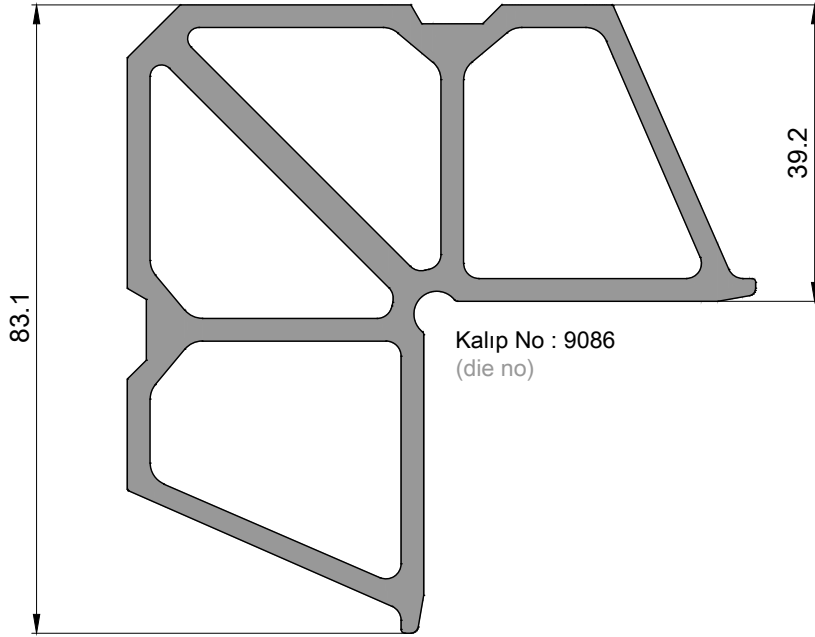

P 2197

Köşe Takoz Profili / 3,385kg/mt

Corner Cleat Profile

Kalıp No : 9086
(die no)

P 1164

50x50x2 Alu Köşebent / 0,540kg/mt

50x50x2 Alu Angle

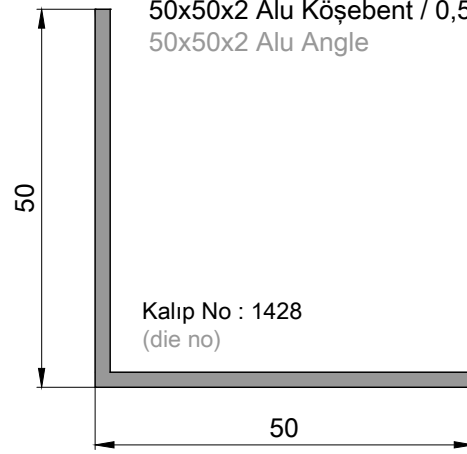

Kalıp No : 1428
(die no)

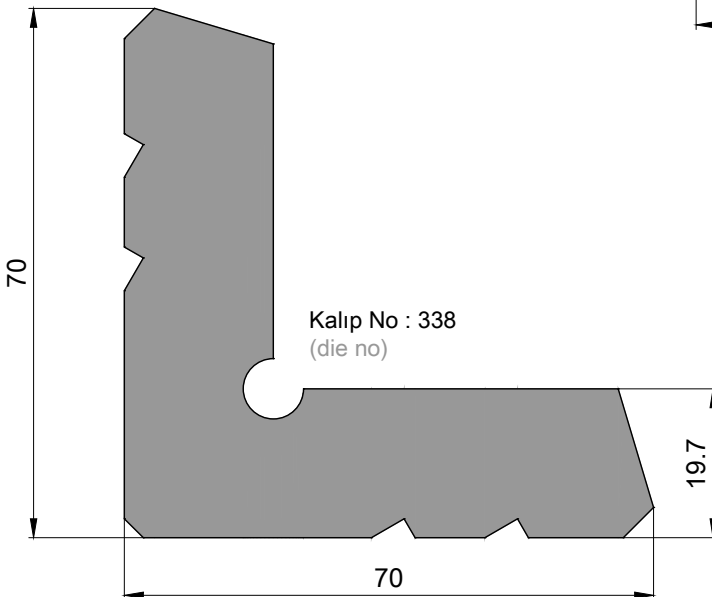

Kalıp No : 338
(die no)

P 1015

Köşe Takoz Profili / 5,990kg/mt

Corner Cleat Profile

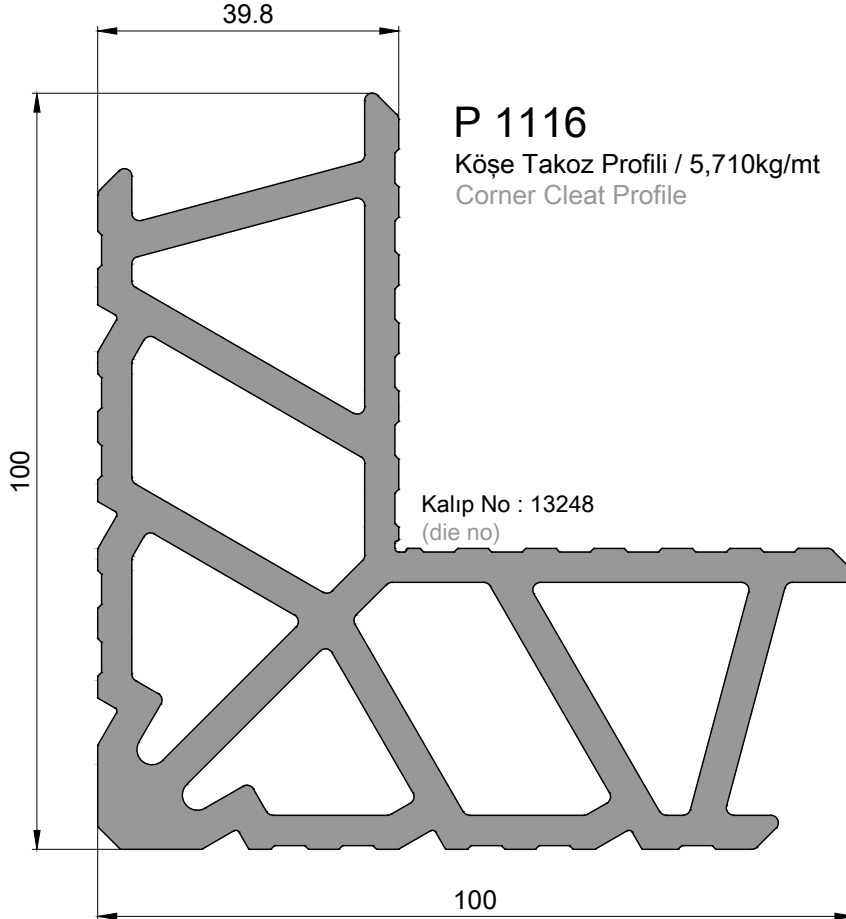
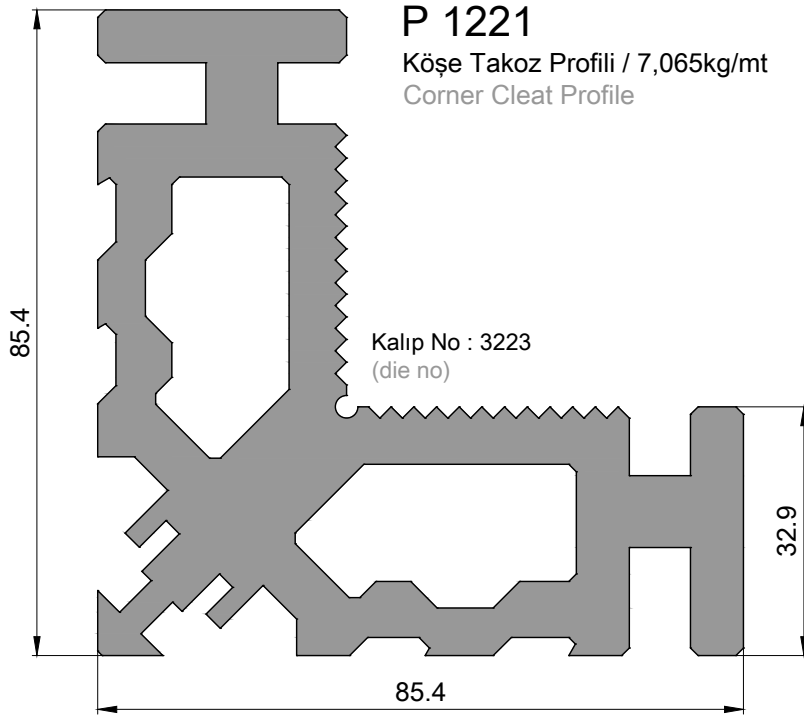

KPW63 TSN
PENCERE SİSTEMİ
PUNCH WINDOW SYSTEM

PRENSİP SİSTEM DETAYLARI
PRINCIPAL SECTIONS

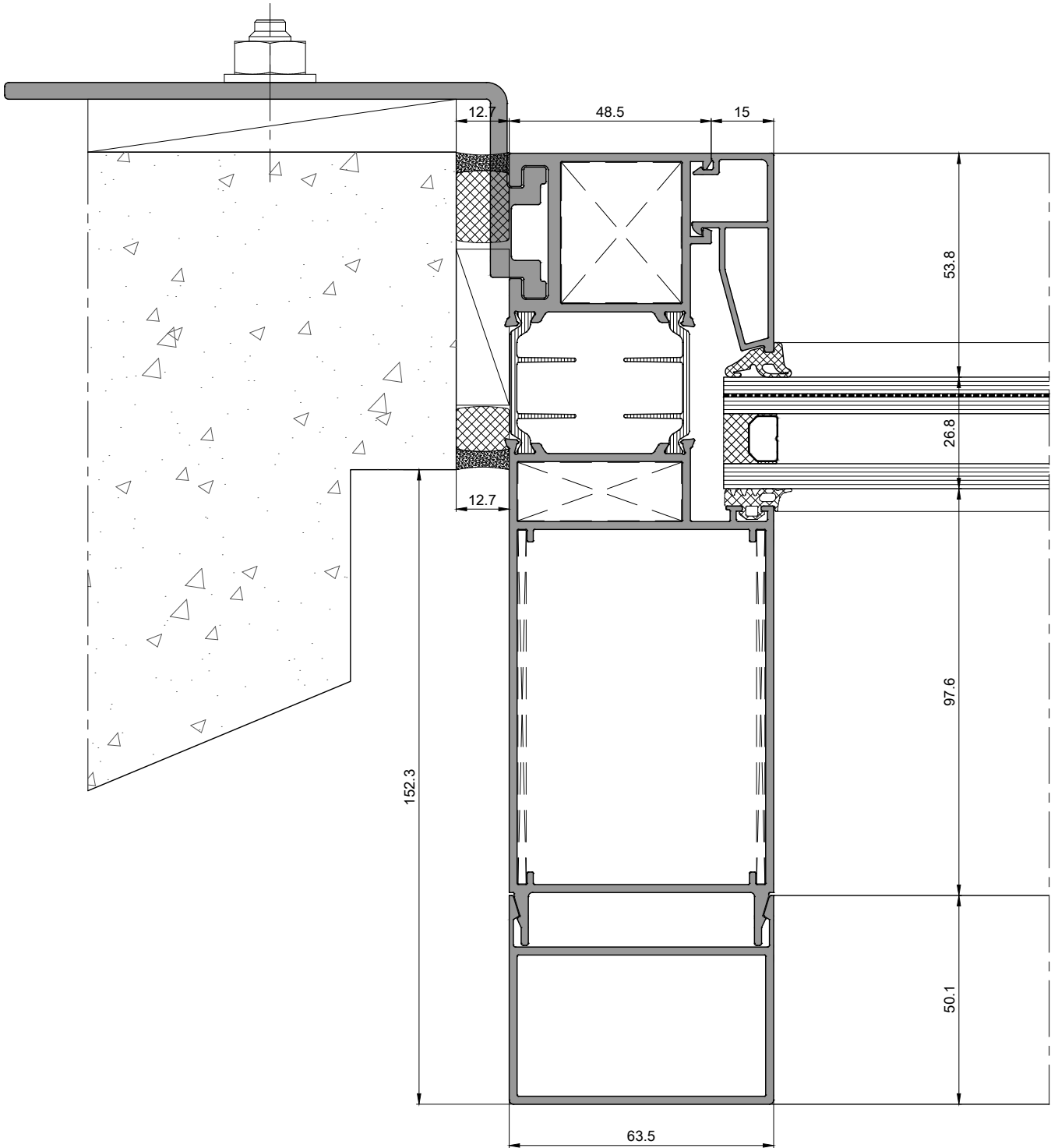
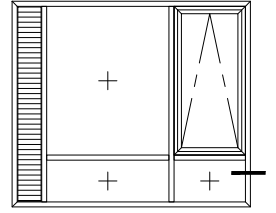

- a) Menfez profilleri ve sistemi KLEIDCO ya ait değildir.
Aşağıda detayda gösterilen çıta, conta ve 20x40x2 kutu profil KLEIDCO ya aittir
- a) Louver profiles and system do not belong to KLEIDCO. The glazing bead, gasket and 20x40x2 box profile shown in detail below belong to KLEIDCO.
- b) Montaj ankraj uzunluğu ve aralıklarının belirlenmesinden ve kullanılacak vidanın çap ve boy gibi özelliklerinden KLEIDCO sorumlu değildir.
- c) KLEIDCO is not responsible for the determination of strap anchor length and spacing, and the diameter and length of the screw to be used.

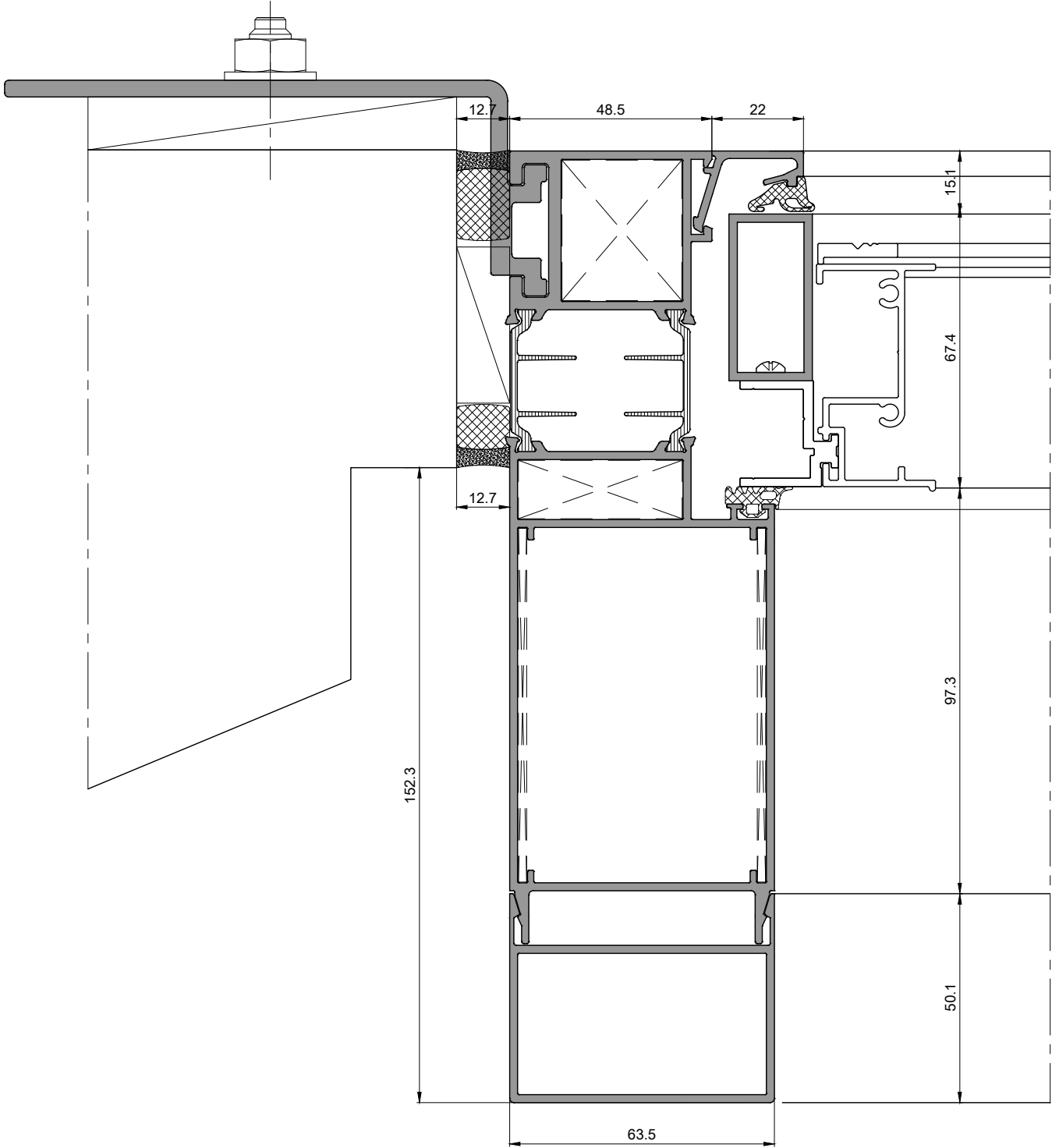
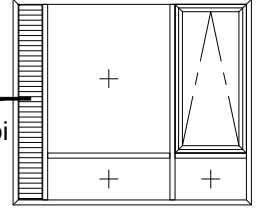

- a) Menfez profilleri ve sistemi KLEIDCO ya ait değildir.
Aşağıda detayda gösterilen çıta, conta ve 20x40x2 kutu profil KLEIDCO ya aittir
- a) Louver profiles and system do not belong to KLEIDCO. The glazing bead, gasket and 20x40x2 box profile shown in detail below belong to KLEIDCO.
- b) Montaj ankraj uzunluğu ve aralıklarının belirlenmesinden ve kullanılacak vidanın çap ve boy gibi özelliklerinden KLEIDCO sorumlu değildir.
- c) KLEIDCO is not responsible for the determination of strap anchor length and spacing, and the diameter and length of the screw to be used.

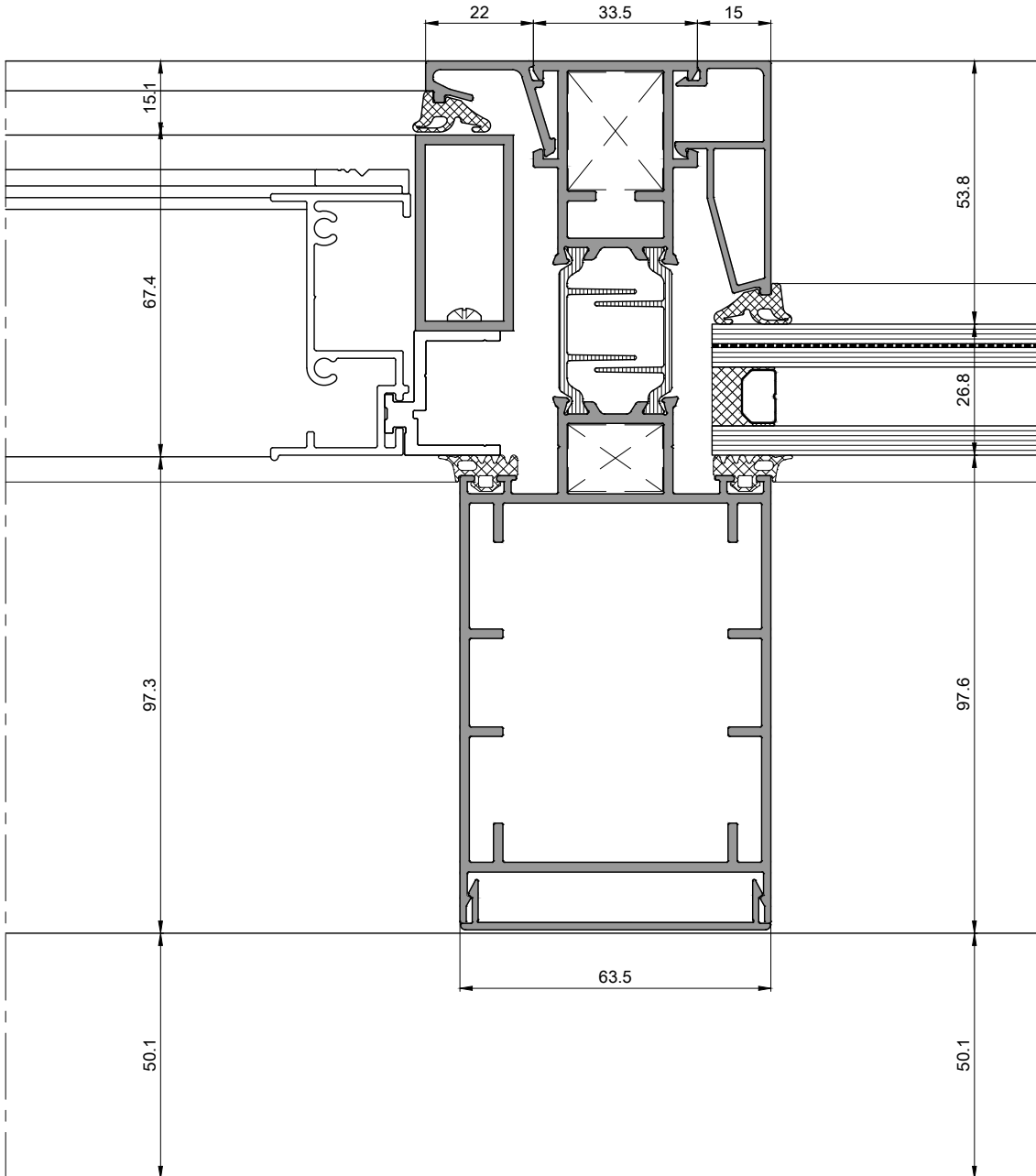
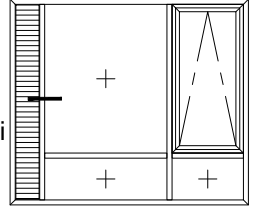

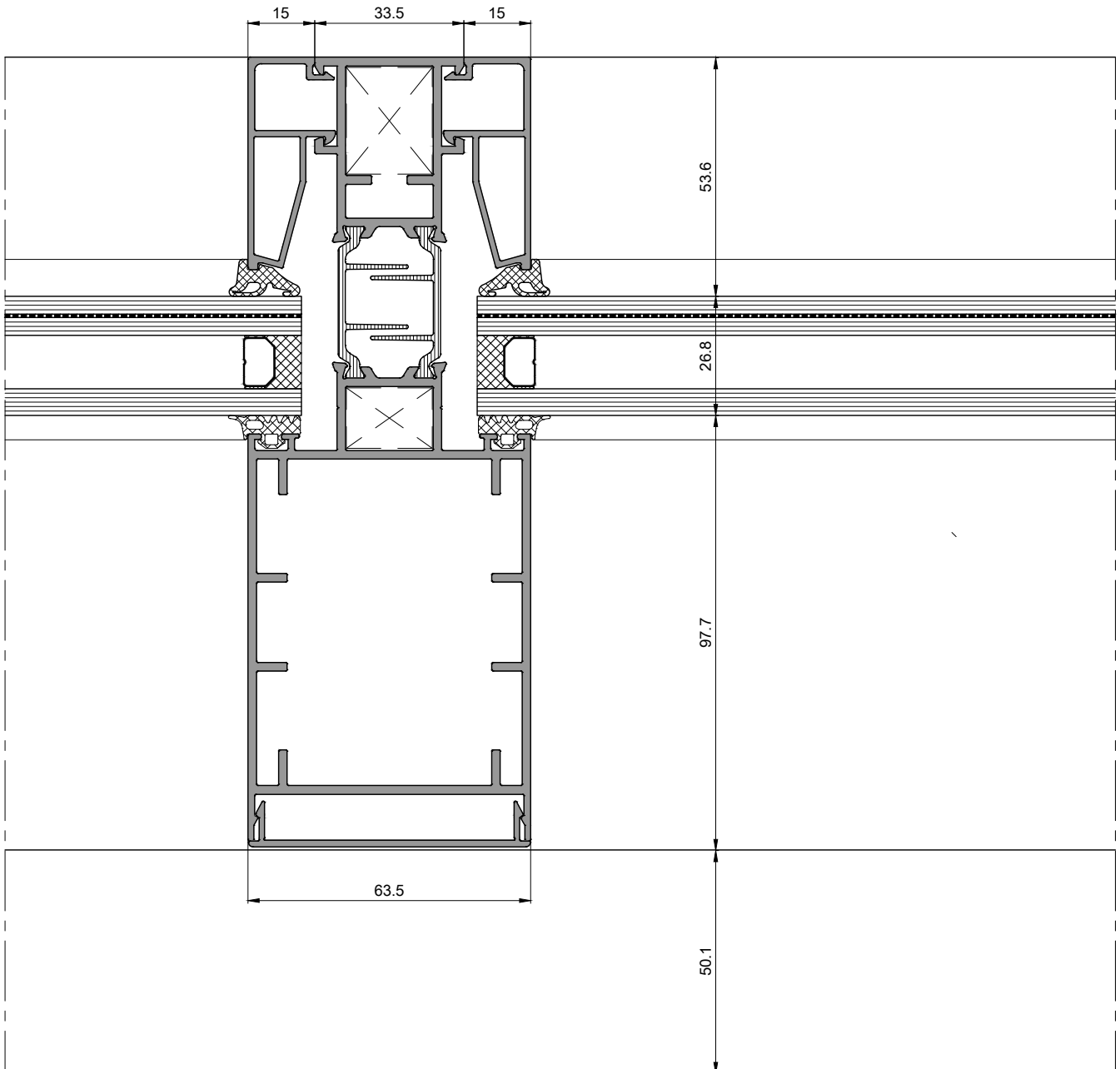
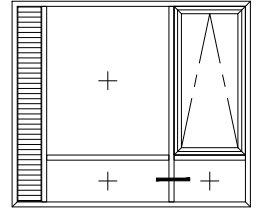

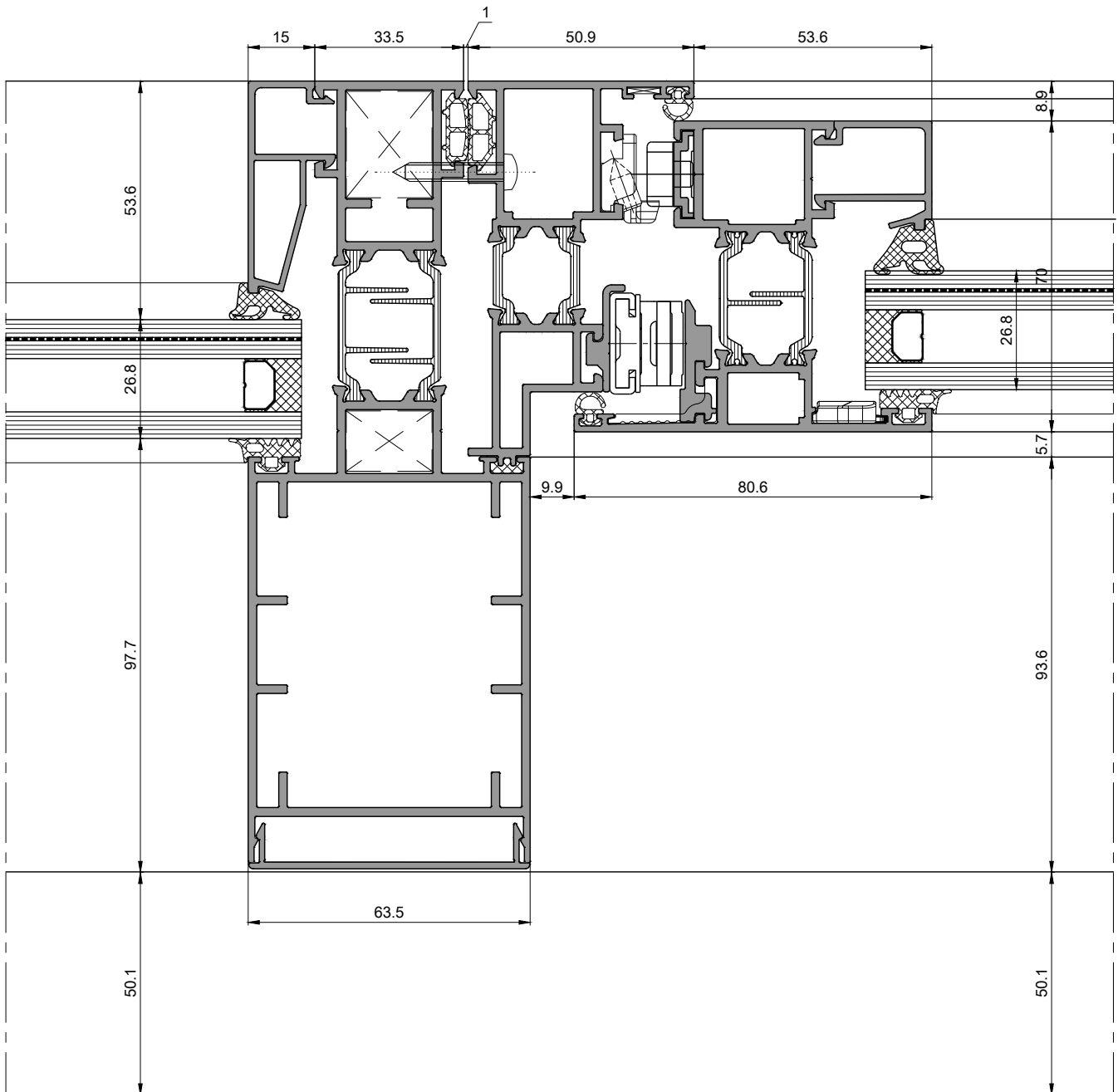
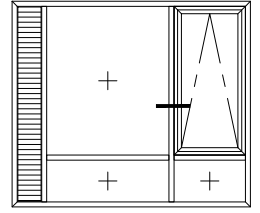

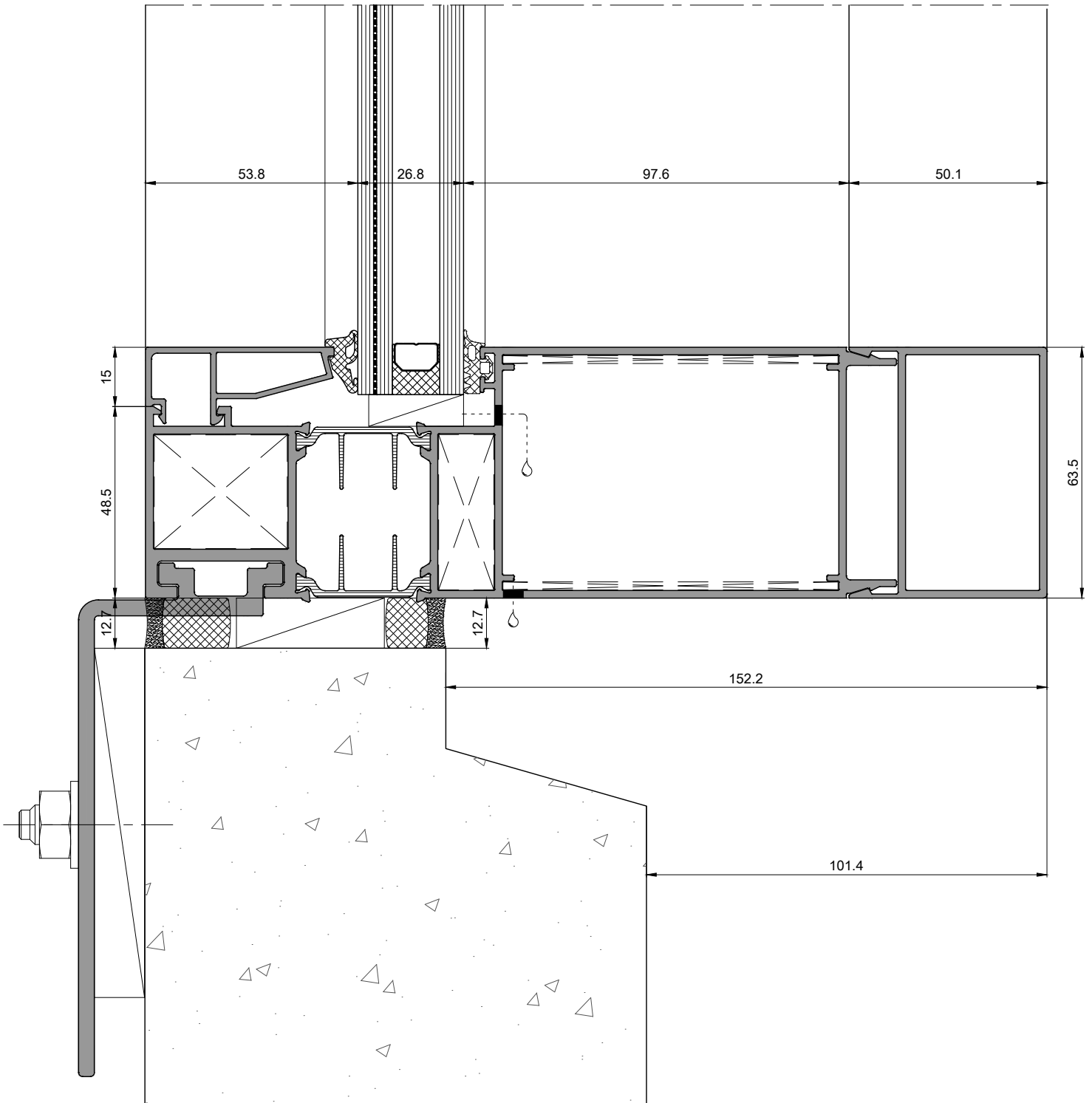
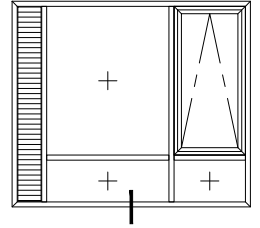

- a) Menfez profilleri ve sistemi KLEIDCO ya ait değildir. Aşağıda detayda gösterilen çıta, conta ve 20x40x2 kutu profil KLEIDCO ya aittir
- a) Louver profiles and system do not belong to KLEIDCO. The glazing bead, gasket and 20x40x2 box profile shown in detail below belong to KLEIDCO.
- b) Montaj ankraj uzunluğu ve aralıklarının belirlenmesinden ve kullanılacak vidanın çap ve boy gibi özelliklerinden KLEIDCO sorumlu değildir.
- c) KLEIDCO is not responsible for the determination of strap anchor length and spacing, and the diameter and length of the screw to be used.

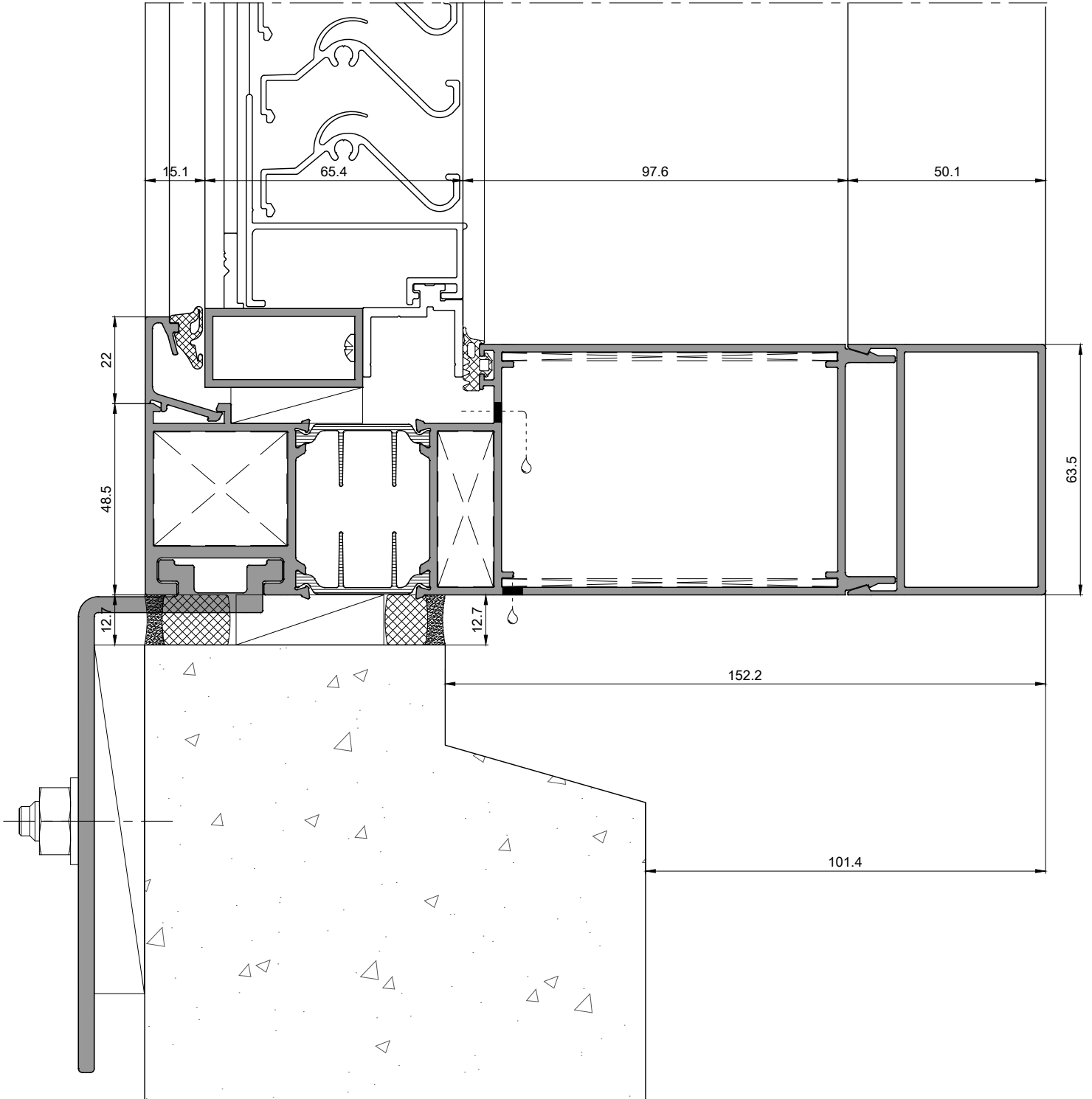
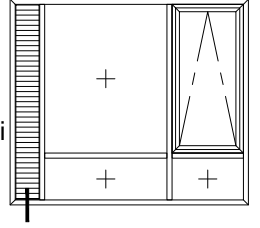

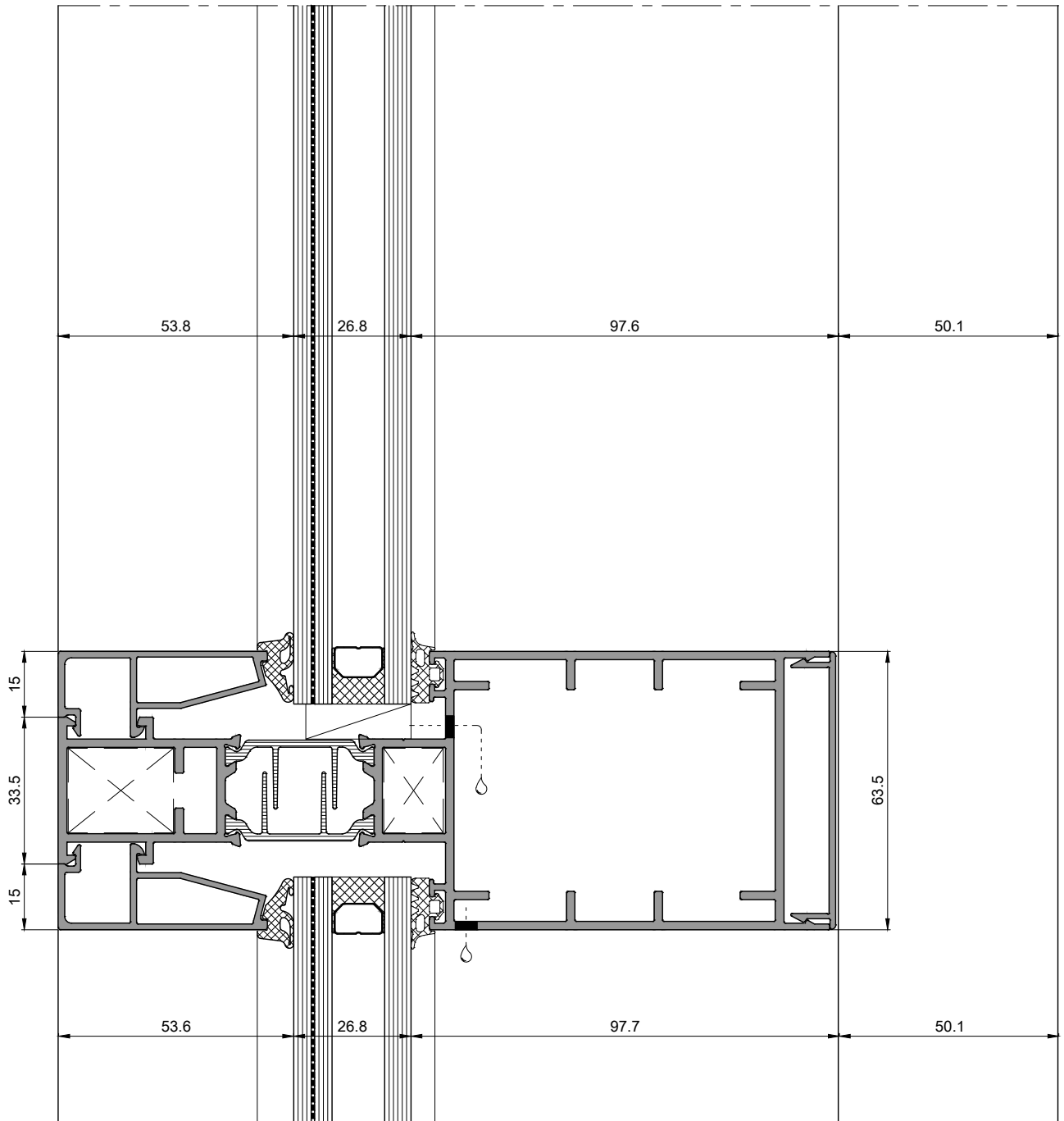
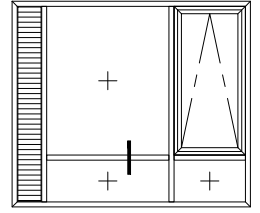

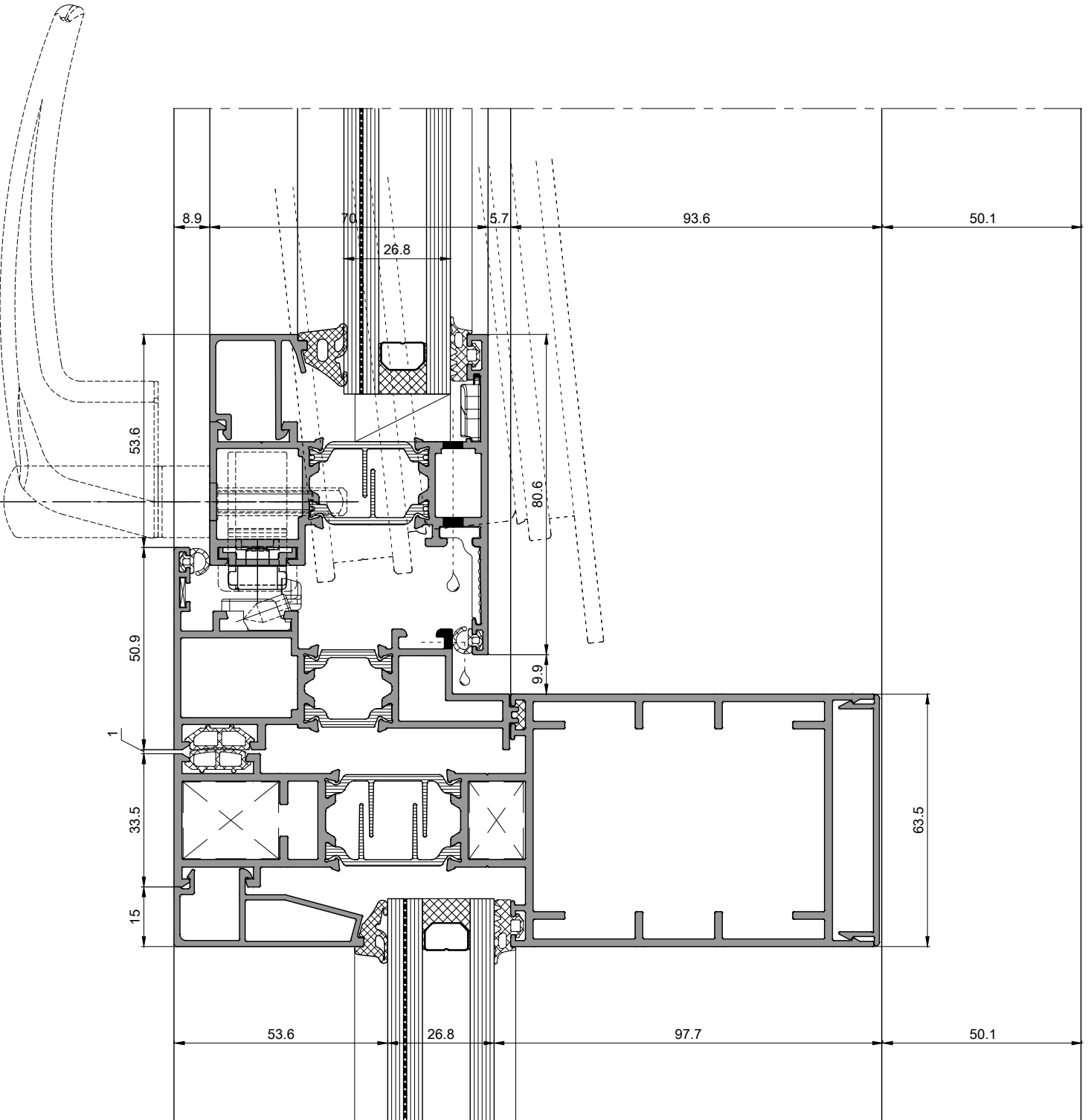
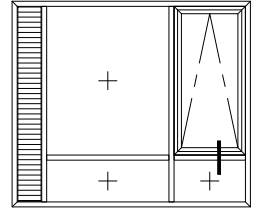

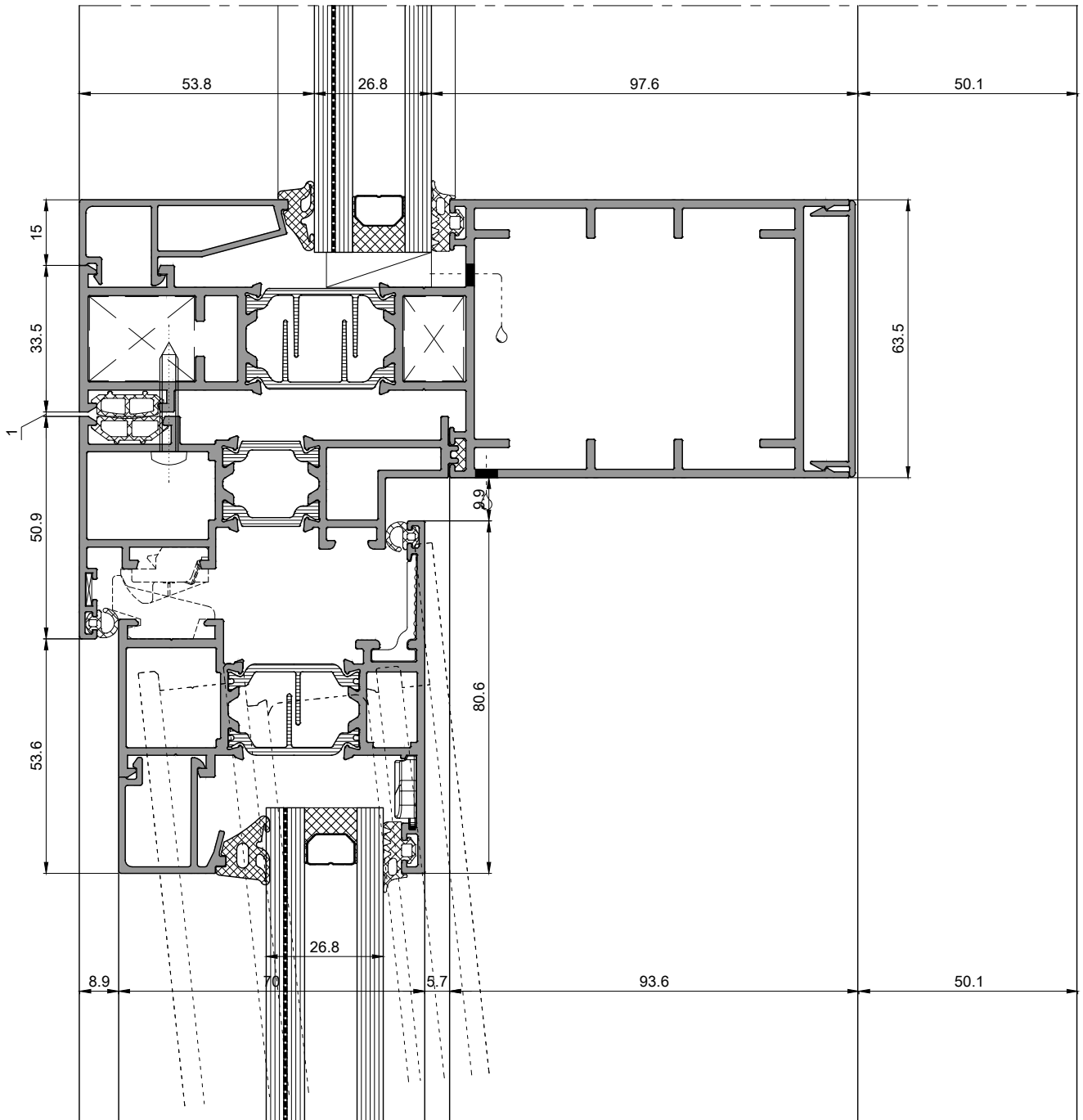
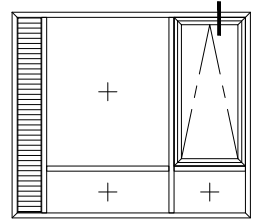

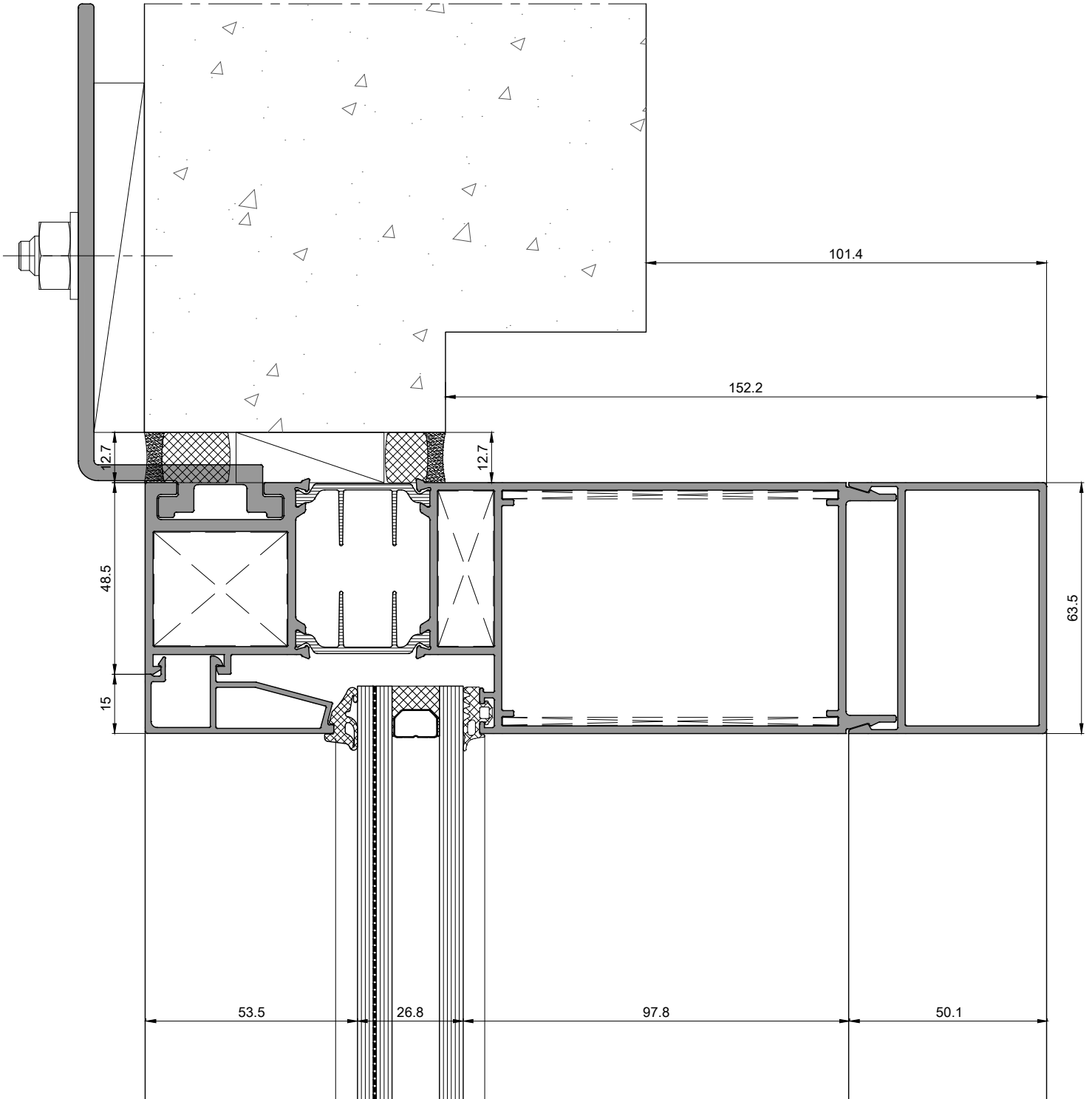
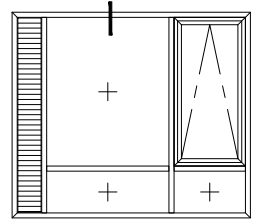

- a) Menfez profilleri ve sistemi KLEIDCO ya ait değildir.
Aşağıda detayda gösterilen çıta, conta ve 20x40x2 kutu profil KLEIDCO ya aittir
- a) Louver profiles and system do not belong to KLEIDCO. The glazing bead, gasket and 20x40x2 box profile shown in detail below belong to KLEIDCO.
- b) Montaj ankraj uzunluğu ve aralıklarının belirlenmesinden ve kullanılacak vidanın çap ve boy gibi özelliklerinden KLEIDCO sorumlu değildir.
- c) KLEIDCO is not responsible for the determination of strap anchor length and spacing, and the diameter and length of the screw to be used.

